

EMBRAER 190

EMBRAER S.A.
12227-901 SAO JOSE DOS CAMPOS - S.P.
BRAZIL
PHONE: + 55 12 3927-7517
<http://www.flyembraer.com>
e-mail: distrib@embraer.com.br

AIRPORT PLANNING MANUAL

In connection with the use of this document, Embraer does not provide any express or implied warranties and expressly disclaims any warranty of merchantability or fitness for a particular purpose.

This document contains trade secrets, confidential, proprietary information of Embraer and technical data subject to U.S. Export Administration Regulation ("EAR") and other countries export control laws and regulations. Diversion contrary to the EAR and other laws and regulations is strictly forbidden. The above restrictions may apply to data on all pages of this document.

APM - 1901
15 AUGUST 2005
REVISION 22 - 23 JUNE 2023



TABLE OF CONTENTS

| <u>SUBJECT</u> | <u>REVISION STATUS</u> | <u>REVISION DATE</u> |
|--|-----------------------------------|---------------------------------|
| RECORD OF REVISIONS | R | Jun 23/23 |
| HIGHLIGHTS | R | Jun 23/23 |
| INTRODUCTION | R | Jun 23/23 |
| SECTION 01 Scope | U | Nov 26/21 |
| SECTION 02 Aircraft Description | U | May 27/22 |
| SECTION 03 Aircraft Performance | U | Nov 26/21 |
| SECTION 04 Ground Maneuvering | U | Nov 26/21 |
| SECTION 05 Terminal Servicing | U | Nov 26/21 |
| SECTION 06 Operating Conditions | U | Nov 26/21 |
| SECTION 07 Pavement Data | U | May 27/22 |
| SECTION 08 Possible EMBRAER 190 Derivative Aircraft | U | Nov 26/21 |
| SECTION 09 Scaled Drawings | U | Nov 26/21 |

Revision Status: U - Unchanged, R - Revised, N - New, D - Deleted

Embraer 190 - APM 1901

TOCPage 1 of 1
Rev 22 - Jun 23/23



RECORD OF REVISIONS

This list is intended to show the Operator the cumulative issued revisions to his manual. The list consists of the revision number and the respective issuance date.

| REV NO. | ISSUE DATE |
|----------------|-------------------|
| 0 | Aug 15/05 |
| 1 | Jan 09/06 |
| 2 | Jun 29/06 |
| 3 | Dec 18/06 |
| 4 | May 11/07 |
| 5 | Oct 22/07 |
| 6 | Oct 07/08 |
| 7 | Oct 07/10 |
| 8 | Oct 06/11 |
| 9 | Oct 31/12 |
| 10 | Feb 18/13 |
| 11 | Oct 07/13 |
| 12 | Oct 07/14 |
| 13 | Oct 09/15 |
| 14 | May 25/18 |
| 15 | Aug 09/19 |
| 16 | Sep 27/19 |
| 17 | May 22/20 |
| 18 | May 21/21 |
| 19 | Aug 27/21 |
| 20 | Nov 26/21 |
| 21 | May 27/22 |
| 22 | Jun 23/23 |



HIGHLIGHTS

Content which have been added, revised or deleted by the current revision are indicated on the "Table of Contents".



INTRODUCTION

1. Applicability

The table below provides a cross-reference between the commercial and certification designations of the aircraft:

Table 1 - AIRCRAFT DESIGNATIONS

| AIRCRAFT COMMERCIAL DESIGNATION | AIRCRAFT CERTIFICATION DESIGNATION |
|--|---|
| EMBRAER 190 STD | ERJ 190-100 STD |
| EMBRAER 190 LR | ERJ 190-100 LR |
| EMBRAER 190 AR | ERJ 190-100 IGW |
| EMBRAER 190 SR | ERJ 190-100 SR |

2. General

The APM has been prepared in accordance with NAS 3601.

It provides aircraft characteristics for general airport planning, airport operators, airlines, and engineering consultant organizations.

The APM is arranged as shown in the table below:

Table 2 - APM Arrangement

| ARRANGEMENTS | CONTENTS |
|---------------------|------------------------------|
| Manual Front Matter | Title Page |
| | Highlights |
| | Record of Revision Sheet |
| | Table of Contents |
| | Introduction |
| Section | Scope |
| | Aircraft Description |
| | Aircraft Performance |
| | Ground Maneuvering |
| | Terminal Servicing |
| | Operating Conditions |
| | Pavement Data |
| | Possible Derivative Aircraft |
| Scaled Drawings | |

The front matter for the whole manual contains:

- Title Page: Shows the manufacturer's masthead, identification of the manual, initial issue date, and revision number and date.
- Highlights: Advises the operator on the revised pages.
- Record of Revisions Sheet: Lists the successive revision numbers, issue date, insertion date and incorporators initials, which must be kept current by the operator.



- Table of Contents: Lists content with the latest issue dates and provides information to let the reader to quickly and accurately locate the material sought.
- Queries concerning any printed material, including purchasing, copying, shipping and handling, complaints, or compliments may be addressed to:
 Technical Publications Distribution:
 Embraer S.A.
 Attention of: Technical Publications Department
 CEP. 12.227-901- São José dos Campos - SP - Brazil
 Phone: (55 12) 3927-7517
<http://www.embraer.com>
 e-mail: distrib@embraer.com.br
- For support regarding technical information contained in non-operational publication, please contact:
 Routine Issues: Contact Embraer Customer Support Service
 AOG Issues: Contact Embraer AOG group directly

A. Revisions

Embraer may revise this manual periodically as required to update information or provide information not available at the time of printing.

Revised data may result from Embraer approved aircraft modifications and new available options. Changes to the text are indicated by a black bar in the page left-side margin beside the revised, added, or deleted material.

Relocated or rearranged text or illustrations will be indicated by a black bar beside the page number.

3. Abbreviations

This list gives all the abbreviations, acronyms and measurement units used in this manual with their definitions.

Table 3 - List of Acronyms and Abbreviations used in the APM

| ACRONYMS AND ABBREVIATIONS | DESCRIPTION |
|-----------------------------------|---|
| °C | Degree Celsius |
| °F | Degree Fahrenheit |
| ℓ | Liter |
| ACN | Aircraft Classification Number |
| AFM | Airplane Flight Manual |
| AOM | Airplane Operations Manual |
| APU | Auxiliary Power Unit |
| AR | Advanced Range |
| ATTCS | Automatic Takeoff-Thrust Control-System |
| BOW | Basic Operating Weight |
| CBR | California Bearing Ratio |
| dBA | A-Weighted Decibel |
| ECS | Environmental Control System |



(Continued)

Table 3 - List of Acronyms and Abbreviations used in the APM

| ACRONYMS AND ABBREVIATIONS | DESCRIPTION |
|-----------------------------------|---|
| FAA | Federal Aviation Administration |
| FAR | Federal Aviation Regulations |
| ft | Foot |
| ft ² | Square Foot |
| ft ³ | Cubic Foot |
| FWD | Forward |
| gal. | Gallon |
| GEAE | General Electric Aircraft Engines |
| ICAO | International Civil Aviation Organization |
| in | Inch |
| in ² | Square Inch |
| inHg | Inch of Mercury |
| ISA | International Standard Atmosphere |
| JAR | Joint Aviation Requirements |
| kg | Kilogram |
| kPa | Kilopascal |
| lb | Pound |
| lb/in ³ | Pound per Cubic Inch |
| lbf | Pound Force |
| LCN | Load Classification Number |
| LH | Left-Hand |
| LR | Long Range |
| m | Meter |
| m ² | Square Meter |
| m ³ | Cubic Meter |
| min | Minute |
| MLW | Maximum Landing Weight |
| MRW | Maximum Ramp Weight |
| MTOW | Maximum Takeoff Weight |
| MZFW | Maximum Zero Fuel Weight |
| N | Newton |
| psi | Pounds per Square Inch |
| RBHA | Requisitos Brasileiros de Homologação Aeronáutica |
| RH | Right-Hand |
| STD | Standard |

**1. SCOPE**

EFFECTIVITY: ALL

1.1. PURPOSE

This document provides airplane characteristics for general airport planning. Since the operational practices vary among the airlines, specific data should be coordinated with the using airlines before the facility design is made.

EMBRAER should be contacted for any additional information required.



2. AIRCRAFT DESCRIPTION

EFFECTIVITY: ALL

2.1. AIRCRAFT CHARACTERISTICS

The aircraft is:

- Predominantly metallic;
- Low winged;
- Conventional tailed;
- Monoplane;
- Retractable tricycle-type with twin-wheeled landing-gear.

There are two high bypass ratio turbofan GEAE CF34-10 with 82.3 kN (18500 lbf) maximum takeoff thrust (Sea Level, Static Condition and ISA) installed under the wings.

The aircraft has three versions, with different ranges as a function of the difference between the MTOWs:

- The STD aircraft model - MTOW 47790 kg (105359 lb);
- The LR aircraft model - MTOW 50300 kg (110892 lb);
- The AR aircraft model - MTOW 51800 kg (114199 lb).

2.1.1. Definitions**MRW**

It is the maximum allowed aircraft weight for taxiing or maneuvering on the ground.

MLW

It is the maximum allowed weight at which the aircraft may normally be landed.

MTOW

It is the maximum allowed total loaded aircraft weight at the start of the takeoff run.

BOW

It is the weight of the structure, powerplant, instruments, flight controls, hydraulic, electronic, electrical, air conditioning, oxygen, anti-icing and pressurization systems, interior furnishings, portable and emergency equipment and other items of equipment that are an integral part of the aircraft configuration. It also includes unusable fuel, total engine and APU oil, total hydraulic fluid, toilet fluid and water, potable water, crew and crew baggage, navigation kit (manuals, charts), catering (beverages and food) and removable service equipment for the galley.

MZFW

It is the maximum allowed weight without usable fuel in tanks.

Maximum Payload

It is the difference between the MZFW and the BOW.

**Maximum Seating Capacity**

It is the maximum number of passengers specifically certified or anticipated for certification.

Maximum Cargo Volume

It is the maximum space available for cargo.

Usable Fuel

Fuel available for the aircraft propulsion.

Table 2.1 - Aircraft General Characteristics

| DESIGN WEIGHTS ^[1] | AIRCRAFT MODELS | | |
|-------------------------------------|--|----------------------|----------------------|
| | STD | LR | AR |
| MRW | 47950 kg (105712 lb) | 50460 kg (111245 lb) | 51960 kg (114552 lb) |
| MTOW | 47790 kg (105359 lb) | 50300 kg (110892 lb) | 51800 kg (114199 lb) |
| MLW | 43000 kg (94799 lb) | | 44000 kg (97003 lb) |
| BOW ^[2] | 27900 kg (61509 lb) | | |
| MZFW | 40800 kg (89949 lb) | | 40900 kg (90169 lb) |
| Maximum Payload ^[2] | 12900 kg (28440 lb) | | 13000 kg (28660 lb) |
| Maximum Seating Capacity | 106 passengers | | |
| Maximum Cargo Volume ^[3] | 22.63 m ³ (799.18 ft ³) | | |
| Usable Fuel ^[4] | 13000 kg (28660 lb) | | |
| | 16029 ℓ (4234 gal.) | | |

[1] Applicable for standard models. For further information, refer to AFM and AOM.

[2] Typical standard configuration (weights may vary according to optional equipment installed or interior layouts).

[3] Standard configuration (volume may vary according to optional equipment installed).

[4] Adopted fuel density of 0.811 kg/ℓ (6.77 lb/gal.).

2.2. GENERAL AIRCRAFT DIMENSIONS**2.2.1. External Dimensions**

- Span over winglets - 28.72 m (94 ft 3 in.)
- Height (maximum) - 10.55 m (34 ft 7 in.)
- Overall length - 36.24 m (118 ft 11 in.)

2.2.2. Wing

- Reference area - 92.50 m² (996 ft²)
- Reference aspect ratio - 8.1

2.2.3. Fuselage

- Total Length - 36.24 m (118 ft 11 in.)
- Length of pressurized section - 29.08 m (95 ft 5 in.)



2.2.4. Horizontal Tail

- Span - 12.08 m (39 ft 8 in.)
- Area - 26.00 m² (280 ft²)

2.2.5. Vertical Tail

- Reference area - 16.20 m² (174 ft² 54 in²)



EFFECTIVITY: ALL
General Aircraft Dimensions
Figure 2.1

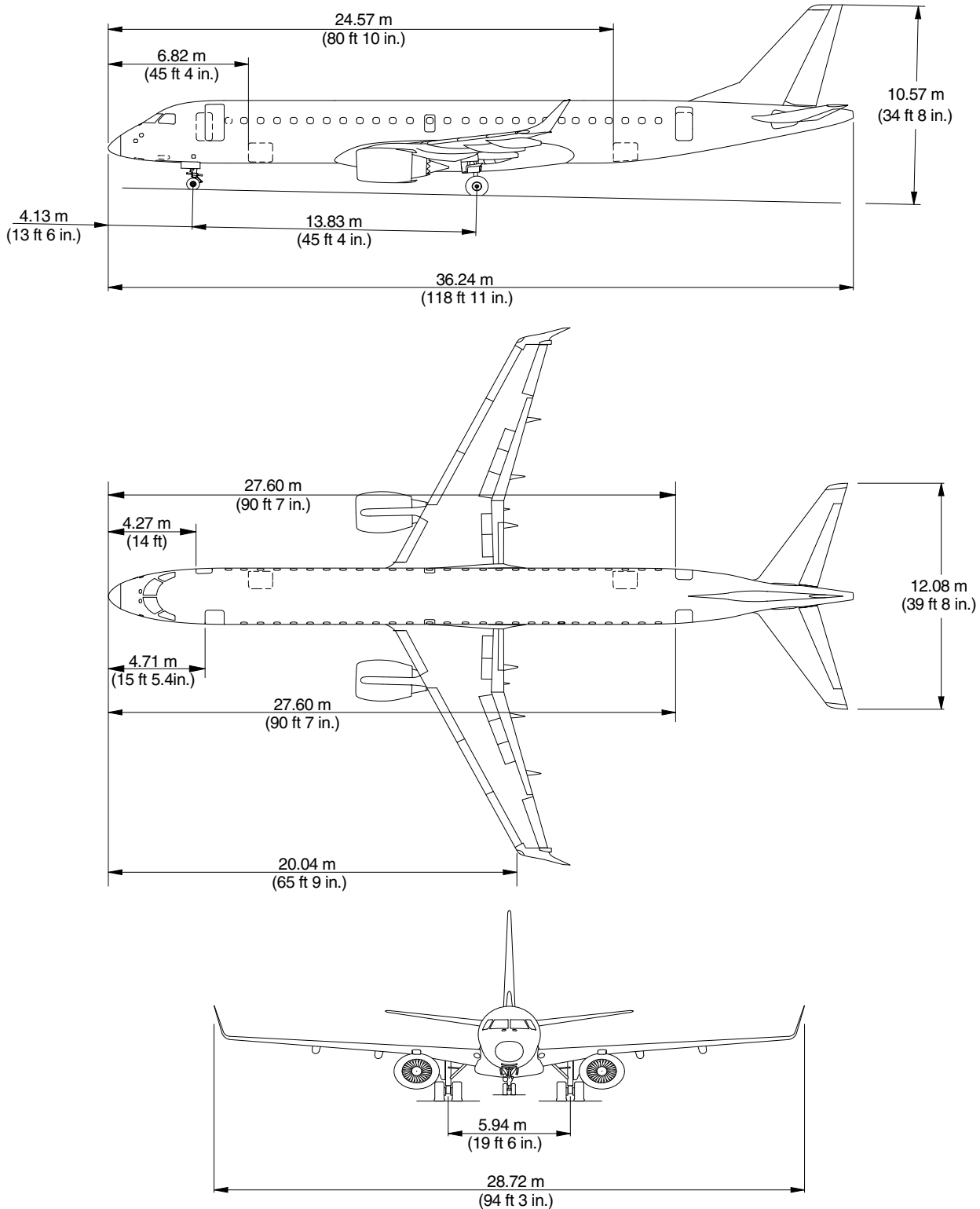

EM170APM020011C.IDR



EFFECTIVITY: ALL
Passenger and Service Doors Dimensions
Figure 2.2 - Sheet 1

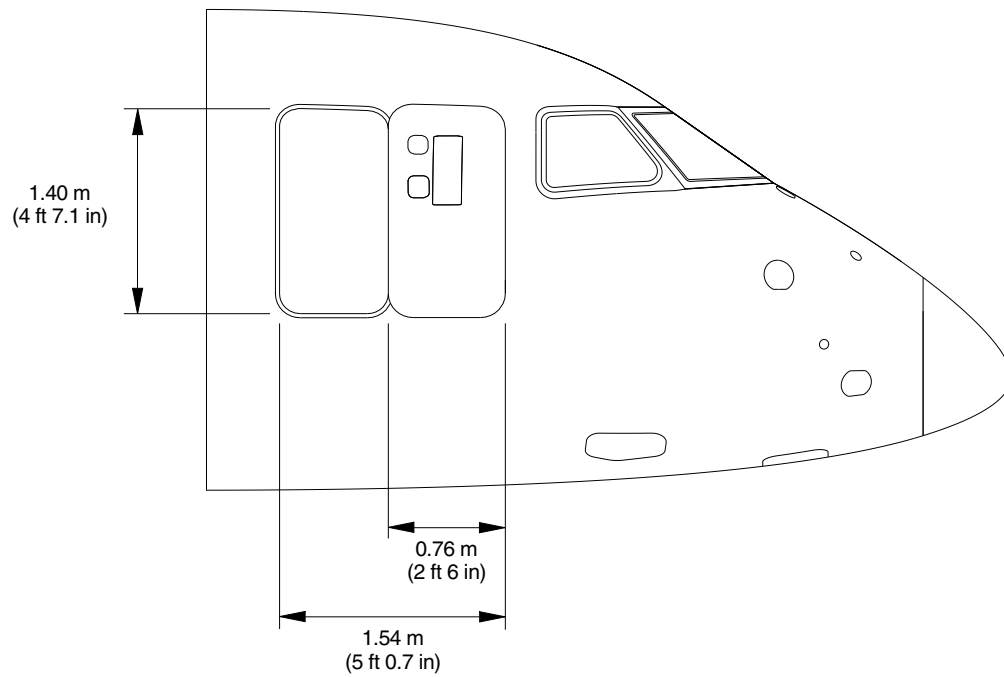
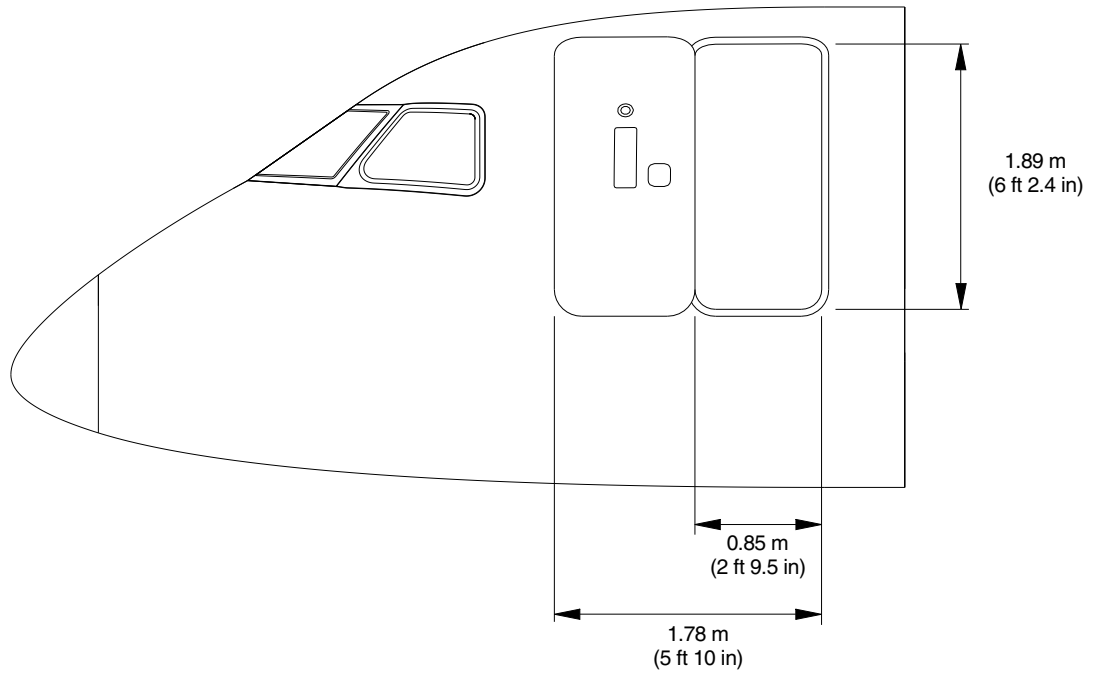

EM170APM020026A>IDR



EFFECTIVITY: ALL

Passenger and Service Doors Dimensions

Figure 2.2 - Sheet 2

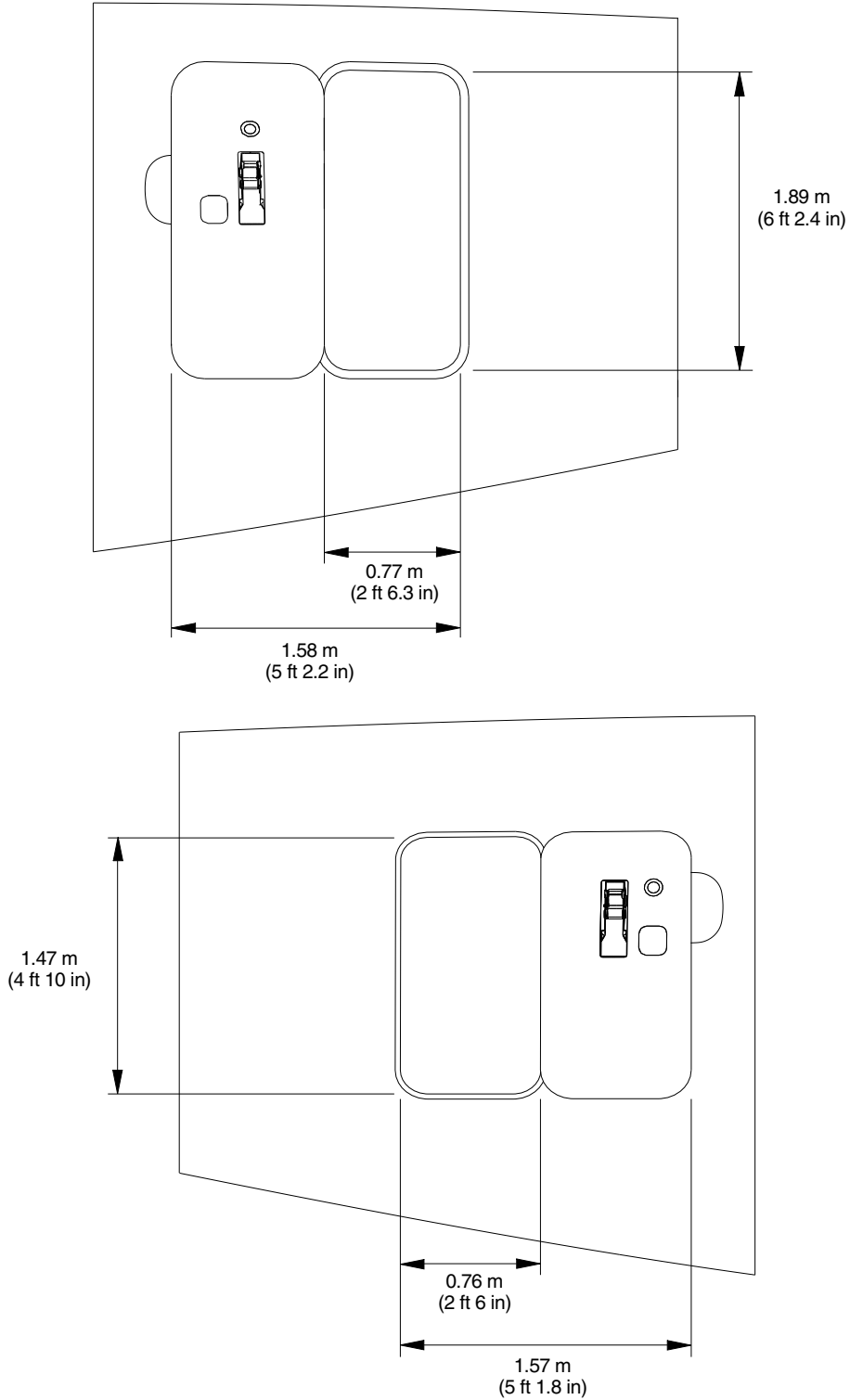

EM170APM020027A.IDR



EFFECTIVITY: ALL

Passenger and Service Doors Dimensions

Figure 2.2 - Sheet 3

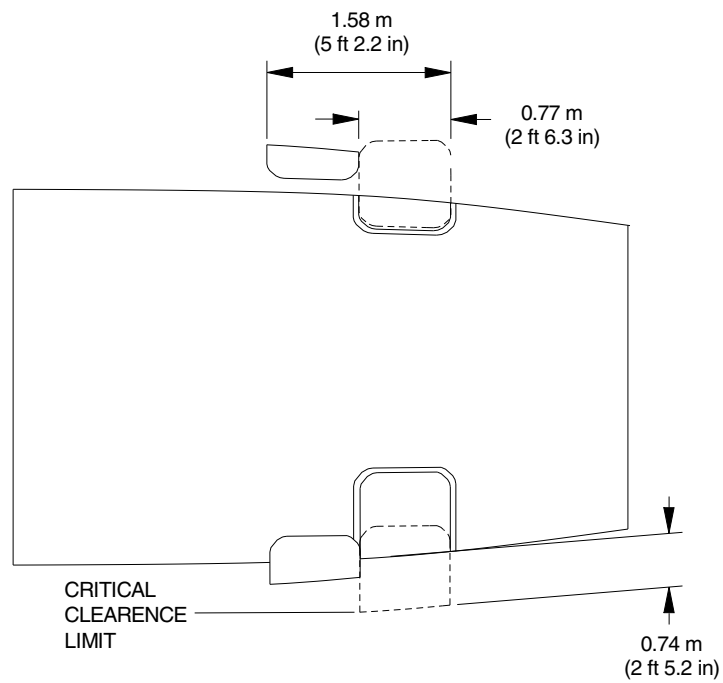
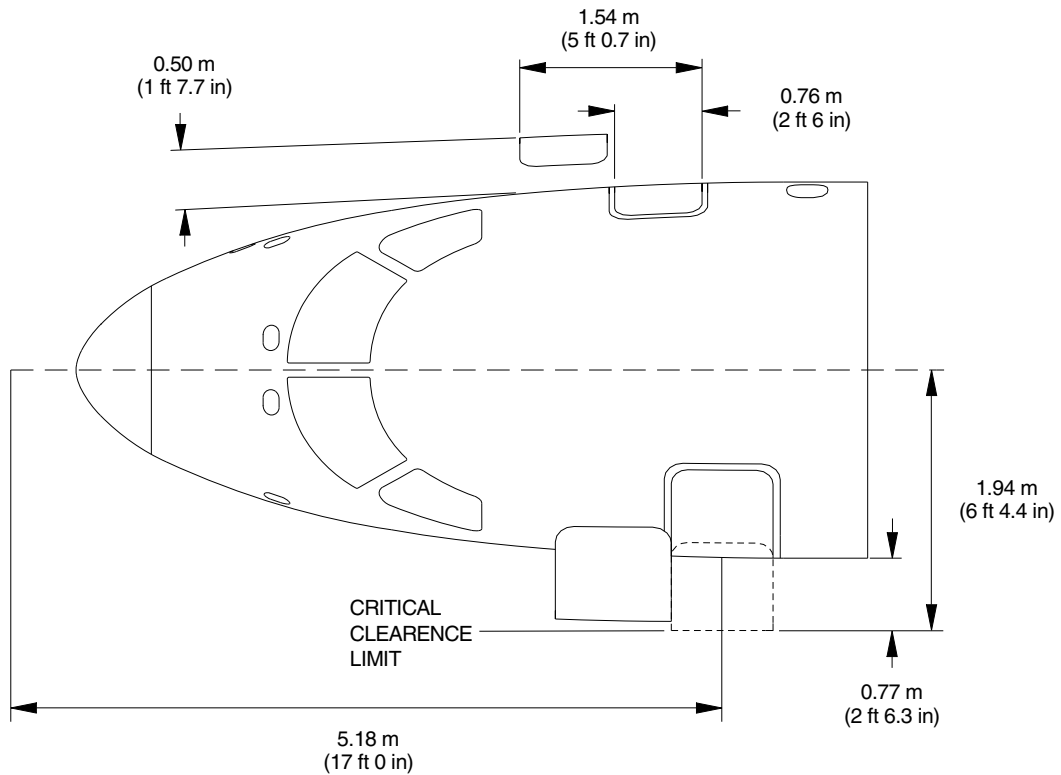

EM170APM020028A>IDR



2.3. **GROUND CLEARANCES**



EFFECTIVITY: ALL
Aircraft Ground Clearances
Figure 2.3

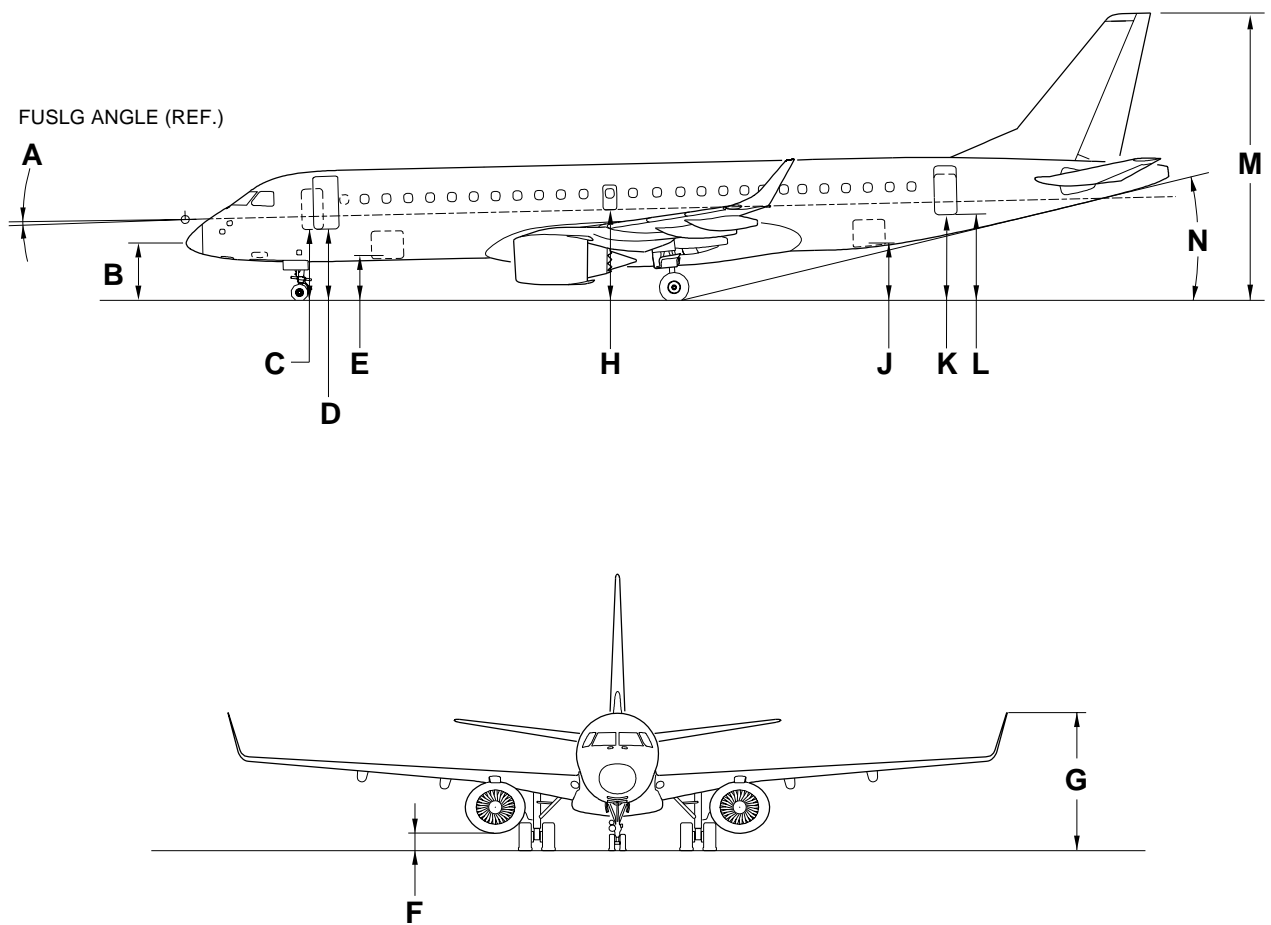

EM170MFEP020013B.DGN



Table 2.2 - Ground Clearance - STD Aircraft Model

| WEIGHT | CG (%MAC) | FUS ANGLE (DEG) (A) | NOSE (B) | FORWARD SERVICE DOOR (C) | FORWARD PASSENGER DOOR (D) | FORWARD CARGO DOOR (E) | NACELLE (F) | WINGLET (G) | EMERGENCY EXIT (H) | AFT CARGO DOOR (J) | AFT SERVICE DOOR (K) | AFT PASSENGER DOOR (L) | VERTICAL TAIL (M) | TAIL SKID ANGLE CLEARANCE (DEG) (N) |
|-----------------------|-----------|---------------------|----------------------|--------------------------|----------------------------|------------------------|----------------------|------------------------|-----------------------|----------------------|-----------------------|------------------------|-------------------------|-------------------------------------|
| 47950 kg 105712 lb | 6.0 | -1.1 | 2.07 m 6 ft 9 in. | 2.58 m 8 ft 5 in. | 2.59 m 8 ft 6 in. | 1.57 m 5 ft 2 in. | 0.49 m 1 ft 7 in. | 5.09 m 16 ft 8 in. | 3.24 m 10 ft 8 in. | 1.99 m 6 ft 5 in. | 3.03 m 9 ft 9 in. | 3.03 m 9 ft 9 in. | 10.40 m 34 ft 2 in. | 12.7 |
| 47950 kg 105712 lb | 28.7 | -0.8 | 2.13 m 7 ft | 2.63 m 8 ft 7 in. | 2.64 m 8 ft 8 in. | 1.61 m 5 ft 3 in. | 0.50 m 1 ft 8 in. | 5.05 m 16 ft 7 in. | 3.24 m 10 ft 8 in. | 1.94 m 6 ft 4 in. | 2.97 m 8 ft 8 in. | 2.97 m 8 ft 8 in. | 10.33 m 33 ft 9 in. | 12.4 |
| 47790 kg 105359 lb | 6.0 | -1.1 | 2.05 m 6 ft 9 in. | 2.58 m 8 ft 5 in. | 2.59 m 8 ft 6 in. | 1.57 m 5 ft 2 in. | 0.49 m 1 ft 7 in. | 5.09 m 16 ft 8 in. | 3.24 m 10 ft 8 in. | 1.99 m 6 ft 6 in. | 3.03 m 9 ft 11 in. | 3.03 m 9 ft 11 in. | 10.43 m 34 ft 2 in. | 12.7 |
| 47790 kg 105359 lb | 28.7 | -0.8 | 2.13 m 7 ft | 2.63 m 8 ft 7 in. | 2.64 m 8 ft 8 in. | 1.61 m 5 ft 3 in. | 0.50 m 1 ft 8 in. | 5.06 m 16 ft 7 in. | 3.24 m 10 ft 8 in. | 1.94 m 6 ft 4 in. | 2.97 m 9 ft 8 in. | 2.97 m 9 ft 8 in. | 10.33 m 33 ft 10 in. | 12.3 |
| 43000 kg 94799 lb | 6.0 | -1.1 | 2.06 m 6 ft 9 in. | 2.59 m 8 ft 6 in. | 2.60 m 8 ft 6 in. | 1.58 m 5 ft 2 in. | 0.50 m 1 ft 8 in. | 5.12 m 16 ft 9 in. | 3.26 m 10 ft 8 in. | 2.00 m 6 ft 7 in. | 3.06 m 9 ft 12 in. | 3.06 m 9 ft 12 in. | 10.45 m 34 ft 3 in. | 12.8 |
| 43000 kg 94799 lb | 29.0 | -0.8 | 2.14 m 7 ft | 2.65 m 8 ft 8 in. | 2.66 m 8 ft 9 in. | 1.63 m 5 ft 4 in. | 0.51 m 1 ft 8 in. | 5.08 m 16 ft 8 in. | 3.26 m 10 ft 8 in. | 1.96 m 6 ft 5 in. | 2.99 m 9 ft 9 in. | 2.99 m 9 ft 9 in. | 10.35 m 33 ft 10 in. | 12.4 |
| 40800 kg 89949 lb | 6.0 | -1.1 | 2.06 m 6 ft 9 in. | 2.59 m 8 ft 6 in. | 2.60 m 8 ft 6 in. | 1.59 m 5 ft 3 in. | 0.51 m 1 ft 8 in. | 5.13 m 16 ft 10 in. | 3.27 m 10 ft 9 in. | 2.02 m 6 ft 7 in. | 3.07 m 10 ft | 3.07 m 10 ft | 10.47 m 34 ft 4 in. | 12.9 |
| 40800 kg 89949 lb | 29.0 | -0.8 | 2.15 m 7 ft | 2.65 m 8 ft 8 in. | 2.66 m 8 ft 9 in. | 1.64 m 5 ft 5 in. | 0.52 m 1 ft 9 in. | 5.09 m 16 ft 8 in. | 3.27 m 10 ft 9 in. | 1.98 m 6 ft 5 in. | 3.00 m 9 ft 10 in. | 3.00 m 9 ft 10 in. | 10.36 m 33 ft 11 in. | 12.5 |



Table 2.3 - Ground Clearance - LR Aircraft Model

| WEIGHT | CG (%MAC) | FUS ANGLE (DEG) (A) | NOSE (B) | FORWARD SERVICE DOOR (C) | FORWARD PASSENGER DOOR (D) | FORWARD CARGO DOOR (E) | NACELLE (F) | WINGLET (G) | EMERGENCY EXIT (H) | AFT CARGO DOOR (J) | AFT SERVICE DOOR (K) | AFT PASSENGER DOOR (L) | VERTICAL TAIL (M) | TAIL SKID ANGLE (DEG) (N) |
|-----------------------|-----------|---------------------|----------------------|--------------------------|----------------------------|------------------------|----------------------|------------------------|-----------------------|----------------------|-----------------------|------------------------|-------------------------|---------------------------|
| 50460 kg 111245 lb | 8.8 | -1.1 | 2.06 m 6 ft 9 in. | 2.58 m 8 ft 5 in. | 2.58 m 8 ft 5 in. | 1.57 m 5 ft 2 in. | 0.48 m 1 ft 7 in. | 5.08 m 16 ft 8 in. | 3.23 m 10 ft 7 in. | 1.97 m 6 ft 5 in. | 3.02 m 9 ft 10 in. | 3.02 m 9 ft 10 in. | 10.40 m 34 ft 1 in. | 12.6 |
| 50460 kg 111245 lb | 27.6 | -0.8 | 2.12 m 7 ft | 2.62 m 8 ft 8 in. | 2.63 m 8 ft 7 in. | 1.60 m 5 ft 4 in. | 0.49 m 1 ft 7 in. | 5.05 m 16 ft 7 in. | 3.24 m 10 ft 7 in. | 1.94 m 6 ft 4 in. | 2.97 m 9 ft 8 in. | 2.97 m 9 ft 8 in. | 10.33 m 33 ft 9 in. | 12.3 |
| 50300 kg 110892 lb | 8.8 | -1.1 | 2.06 m 6 ft 9 in. | 2.58 m 8 ft 5 in. | 2.58 m 8 ft 5 in. | 1.57 m 5 ft 2 in. | 0.48 m 1 ft 7 in. | 5.08 m 16 ft 8 in. | 3.23 m 10 ft 7 in. | 1.97 m 6 ft 5 in. | 3.02 m 9 ft 10 in. | 3.02 m 9 ft 10 in. | 10.40 m 34 ft 1 in. | 12.6 |
| 50300 kg 110892 lb | 27.6 | -0.8 | 2.12 m 7 ft | 2.62 m 8 ft 8 in. | 2.63 m 8 ft 7 in. | 1.60 m 5 ft 4 in. | 0.49 m 1 ft 7 in. | 5.05 m 16 ft 7 in. | 3.24 m 10 ft 7 in. | 1.94 m 6 ft 4 in. | 2.97 m 9 ft 8 in. | 2.97 m 9 ft 8 in. | 10.33 m 33 ft 9 in. | 12.3 |
| 43000 kg 94799 lb | 6.0 | -1.1 | 2.06 m 6 ft 9 in. | 2.59 m 8 ft 6 in. | 2.60 m 8 ft 6 in. | 1.58 m 5 ft 2 in. | 0.50 m 1 ft 8 in. | 5.12 m 16 ft 9 in. | 3.26 m 10 ft 8 in. | 2.00 m 6 ft 7 in. | 3.06 m 9 ft 12 in. | 3.06 m 9 ft 12 in. | 10.45 m 34 ft 3 in. | 12.8 |
| 43000 kg 94799 lb | 29.0 | -0.8 | 2.14 m 7 ft | 2.65 m 8 ft 8 in. | 2.66 m 8 ft 9 in. | 1.63 m 5 ft 4 in. | 0.51 m 1 ft 8 in. | 5.08 m 16 ft 8 in. | 3.26 m 10 ft 8 in. | 1.96 m 6 ft 5 in. | 2.99 m 9 ft 9 in. | 2.99 m 9 ft 9 in. | 10.35 m 33 ft 10 in. | 12.4 |
| 40800 kg 89949 lb | 6.0 | -1.1 | 2.06 m 6 ft 9 in. | 2.59 m 8 ft 6 in. | 2.60 m 8 ft 6 in. | 1.59 m 5 ft 3 in. | 0.51 m 1 ft 8 in. | 5.13 m 16 ft 10 in. | 3.27 m 10 ft 9 in. | 2.02 m 6 ft 7 in. | 3.07 m 10 ft | 3.07 m 10 ft | 10.47 m 34 ft 4 in. | 12.9 |
| 40800 kg 89949 lb | 29.0 | -0.8 | 2.15 m 7 ft 2 in. | 2.65 m 8 ft 8 in. | 2.66 m 8 ft 9 in. | 1.64 m 5 ft 5 in. | 0.52 m 1 ft 9 in. | 5.09 m 16 ft 8 in. | 3.27 m 10 ft 9 in. | 1.98 m 6 ft 5 in. | 3.00 m 9 ft 10 in. | 3.00 m 9 ft 10 in. | 10.36 m 33 ft 11 in. | 12.5 |



Table 2.4 - Ground Clearance - AR Aircraft Model

| WEIGHT | CG (%MAC) | FUS ANGLE (DEG) (A) | NOSE (B) | FORWARD SERVICE DOOR (C) | FORWARD PASSENGER DOOR (D) | FORWARD CARGO DOOR (E) | NACELLE (F) | WINGLET (G) | EMERGENCY EXIT (H) | AFT CARGO DOOR (J) | AFT SERVICE DOOR (K) | AFT PASSENGER DOOR (L) | VERTICAL TAIL (M) | TAIL SKID ANGLAR CLEARANCE (DEG) (N) |
|----------------------|-----------|---------------------|----------------------|--------------------------|----------------------------|------------------------|----------------------|------------------------|-----------------------|----------------------|-----------------------|------------------------|-------------------------|--------------------------------------|
| 51960 kg 114552lb | 10.7 | -1.1 | 2.06 m 6 ft 9 in. | 2.58 m 8 ft 5 in. | 2.59 m 8 ft 6 in. | 1.57 m 5 ft 2 in. | 0.48 m 1 ft 7 in. | 5.08 m 16 ft 8 in. | 3.23 m 10 ft 7 in. | 1.97 m 6 ft 5 in. | 3.01 m 9 ft 10 in. | 3.01 m 9 ft 10 in. | 10.40 m 34 ft 1 in. | 12.6 |
| 51960 kg 114552lb | 27.0 | -0.8 | 2.12 m 7 ft | 2.62 m 8 ft 8 in. | 2.63 m 8 ft 7 in. | 1.60 m 5 ft 4 in. | 0.49 m 1 ft 7 in. | 5.05 m 16 ft 7 in. | 3.23 m 10 ft 7 in. | 1.93 m 6 ft 4 in. | 2.96 m 9 ft 8 in. | 2.96 m 9 ft 8 in. | 10.32 m 33 ft 9 in. | 12.3 |
| 51800kg 11499lb | 10.7 | -1.1 | 2.06 m 6 ft 9 in. | 2.58 m 8 ft 5 in. | 2.59 m 8 ft 6 in. | 1.57 m 5 ft 2 in. | 0.48 m 1 ft 7 in. | 5.08 m 16 ft 8 in. | 3.23 m 10 ft 7 in. | 1.97 m 6 ft 5 in. | 3.01 m 9 ft 10 in. | 3.01 m 9 ft 10 in. | 10.40 m 34 ft 1 in. | 12.6 |
| 51800kg 11499lb | 27.0 | -0.8 | 2.12m 7 ft | 2.62 m 8 ft 8 in. | 2.63 m 8 ft 7 in. | 1.60 m 5 ft 4 in. | 0.49 m 1 ft 7 in. | 5.05 m 16 ft 7 in. | 3.23 m 10 ft 7 in. | 1.93 m 6 ft 4 in. | 2.96 m 9 ft 8 in. | 2.96 m 9 ft 8 in. | 10.33 m 33 ft 9 in. | 12.3 |
| 44000 kg 97003 lb | 6.0 | -1.1 | 2.06 m 6 ft 9 in. | 2.59 m 8 ft 6 in. | 2.60 m 8 ft 6 in. | 1.58 m 5 ft 2 in. | 0.50 m 1 ft 8 in. | 5.11 m 16 ft 9 in. | 3.26 m 10 ft 8 in. | 2.00 m 6 ft 7 in. | 3.03 m 9 ft 12 in. | 3.03 m 9 ft 12 in. | 10.45 m 34 ft 3 in. | 12.8 |
| 44000 kg 97003 lb | 29.0 | -0.8 | 2.14 m 7 ft | 2.64 m 8 ft 8 in. | 2.65 m 8 ft 8 in. | 1.63 m 5 ft 4 in. | 0.51 m 1 ft 8 in. | 5.07 m 16 ft 8 in. | 3.26 m 10 ft 8 in. | 1.96 m 6 ft 5 in. | 2.99 m 9 ft 9 in. | 2.99 m 9 ft 9 in. | 10.34 m 33 ft 10 in. | 12.4 |
| 40900 kg 90169 lb | 6.0 | -1.1 | 2.06 m 6 ft 9 in. | 2.59 m 8 ft 6 in. | 2.60 m 8 ft 6 in. | 1.59 m 5 ft 3 in. | 0.51 m 1 ft 8 in. | 5.13 m 16 ft 10 in. | 3.27 m 10 ft 9 in. | 2.02 m 6 ft 7 in. | 3.07 m 10 ft | 3.07 m 10 ft | 10.47 m 34 ft 4 in. | 12.9 |
| 40900 kg 90169 lb | 29.0 | -0.8 | 2.15 m 7 ft 2 in. | 2.65 m 8 ft 8 in. | 2.66 m 8 ft 9 in. | 1.63 m 5 ft 4 in. | 0.52 m 1 ft 9 in. | 5.09 m 16 ft 8 in. | 3.27 m 10 ft 9 in. | 1.97 m 6 ft 5 in. | 3.00 m 9 ft 10 in. | 3.00 m 9 ft 10 in. | 10.36 m 33 ft 11 in. | 12.5 |



2.4. **INTERIOR ARRANGEMENTS**

The interior arrangement provides accommodation for two pilots, one observer, three flight attendants, and 98 passengers in 32 in pitch standard configuration. One additional flight attendant seat is available as an option.

2.4.1. Passenger Cabin

The passenger cabin accommodates 98 passengers in 24 double seats on both sides, in 32 in pitch standard configuration.

As an option, the passenger cabin is also provided with some double first-class seats on the RH side and some single first-class seats on the LH side.

The main dimensions of passenger cabin are presented below:

- Height - 2.00 m (6 ft 7 in.)
- Width - 2.74 m (9 ft)
- Aisle wide - 0.49 m (1 ft 7 in.)
- Pitch - 0.82 m (32 in.)



EFFECTIVITY: ALL
Typical Interior Arrangements
Figure 2.4

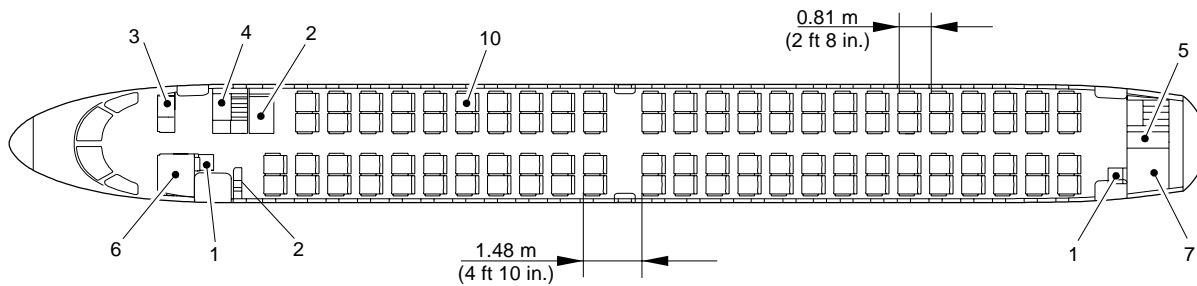
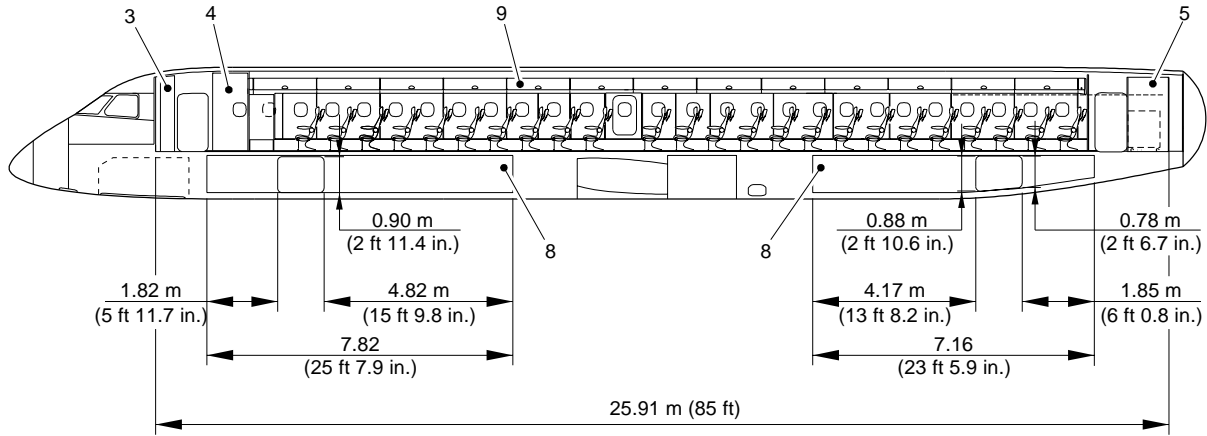

- 1 – FLIGHT ATTENDANT SEAT
- 2 – WARDROBE
- 3 – FWD RH G1 GALLEY
- 4 – FWD RH G2 GALLEY
- 5 – AFT RH GALLEY
- 6 – FWD LAVATORY
- 7 – AFT LAVATORY
- 8 – CARGO COMPARTMENT
- 9 – OVERHEAD BIN
- 10 – PASSENGER SEAT

| CARGO/BAGGAGE VOLUME | |
|----------------------|---|
| CARGO COMPARTMENT | 22.63 m ³ (799.18 ft ³) |
| OVERHEAD BIN | 0.06 m ³ / pax (2.0 ft ³ / pax) |
| UNDERSEAT VOLUME | 0.04 m ³ / pax (1.4 ft ³ / pax) |

EM170APM020013C.DGN



2.4.2. Cargo Compartments

Two cargo compartments are available, located underfloor, one forward of the wing, and another aft of the wing.

The cargo compartments comply with the FAR-25/JAR-25/RBHA-25 "class C" compartment classification.

The table below contain the capacity for the cargo compartment:

Table 2.5 - Capacity for the Cargo Compartment

| CARGO COMPARTMENT | LOADING | VOLUME |
|--------------------------|-------------------|--|
| FWD ^[1] | 1850 kg (4078 lb) | 10.84 m ³ (382.81 ft ³) |
| Aft | 1440 kg (3175 lb) | 7.60 m ³ (268.39 ft ³) |
| Total | 3290 kg (7253 lb) | 18.44 m ³ (651.20 ft ³) |

[1] Standard configuration (loading and volume may vary according to optional equipment installed).

The cargo compartments are provided with the following features:

- Optional vertical nets - to avoid damage due to cargo shifting (two for each cargo compartments). Also, there are provisions for two extra vertical nets in the forward cargo compartment and one in the aft cargo compartment;
- Door net at each cargo door.

2.4.3. Cockpit

The cockpit is acoustically and thermally insulated for appearance and durability. It follows the worldwide trend of rounded edges, which avoids harm to the flight crew.

The cockpit is separated from the passenger cabin by a bulkhead with a lockable door. The cockpit door is provided with lockable means operable only from the cockpit side, spy hole and escape mechanism on the cockpit side.

2.5. **PASSENGER CABIN CROSS SECTION**



EFFECTIVITY: ALL
Economy Class Passenger Cabin Cross-Section
Figure 2.5

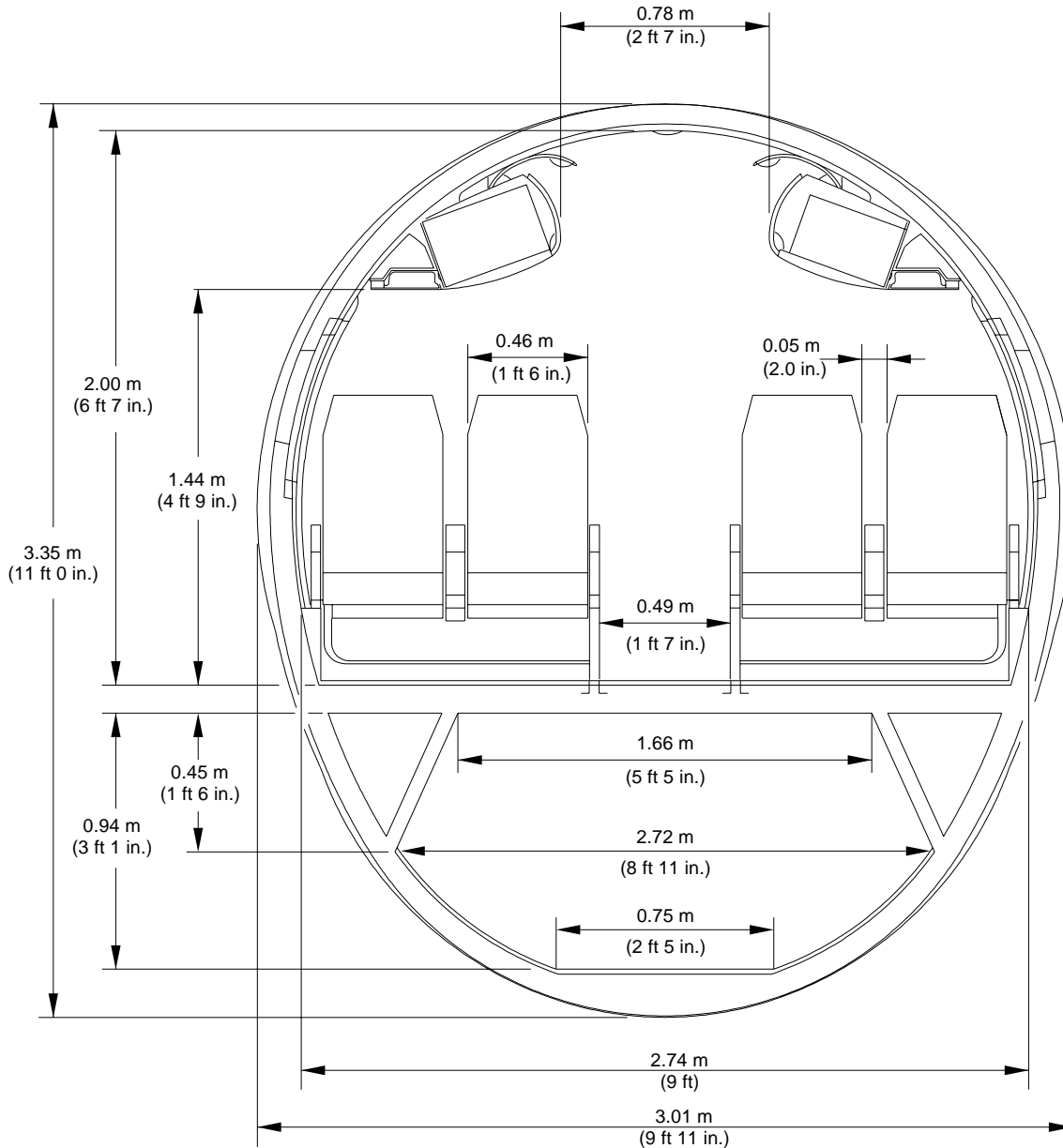

EM170APM020001A.DGN



2.6. **LOWER COMPARTMENT CONTAINERS**

Not Applicable

2.7. **DOOR CLEARANCES**



EFFECTIVITY: ALL
Door Dimensions
Figure 2.7

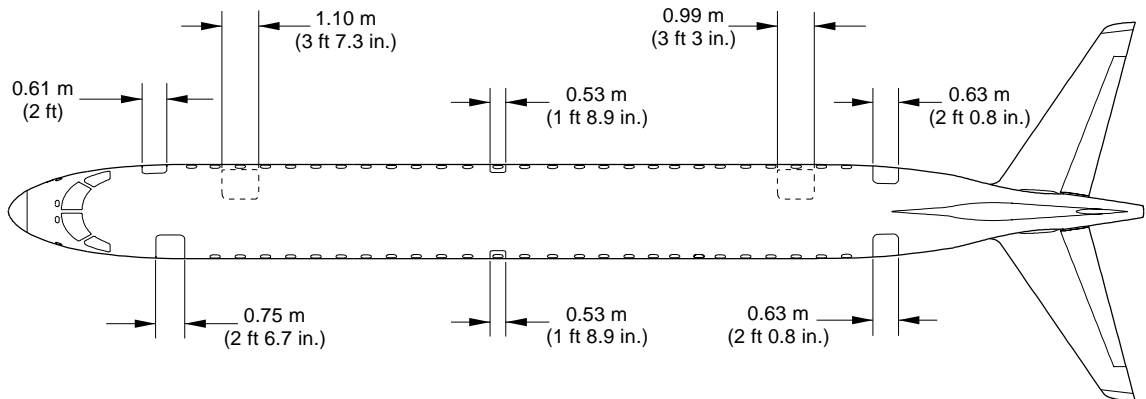
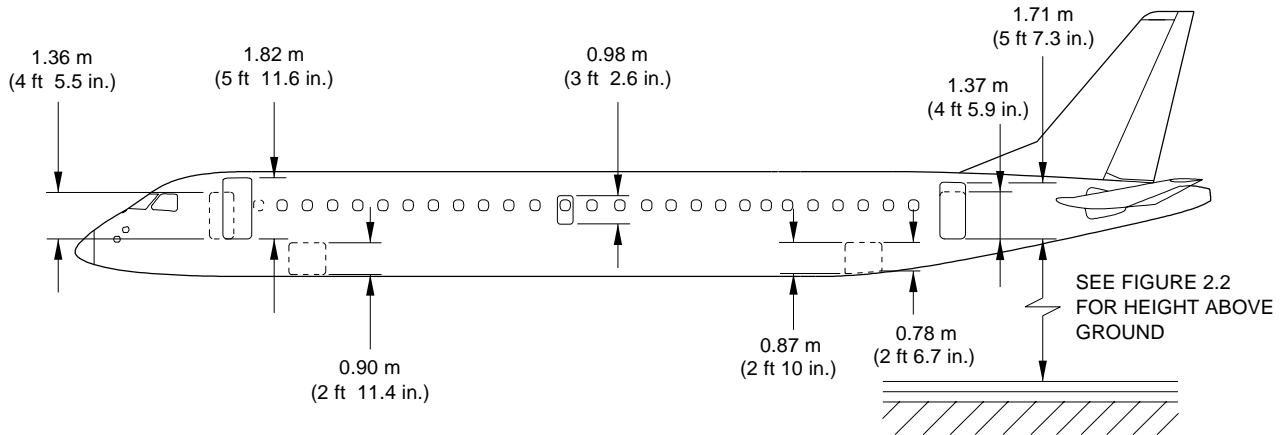

NOTE: FOR DIMENSIONS OF ALL DOORS, CONSIDER THAT AIRCRAFT IS IN OPERATION, THAT IS, EQUIPPED WITH DOOR LININGS AND DOOR SURROUNDS.

EM170APM020014C.DGN

**3. AIRCRAFT PERFORMANCE***EFFECTIVITY: ALL***3.1. GENERAL INFORMATION**

The performance of the aircraft and engine depends on the generation of forces by the interaction between the aircraft or engine and the air mass through which it flies. The atmosphere has a pronounced effect on the temperature, pressure and density of the air.

The ICAO establishes standard basics for estimating and comparing aircraft and engine performance. Some ICAO standard basics are shown below:

1. Sea level standard day:
 Standard Temperature $T_0 = 15\text{ }^\circ\text{C}$ (288.15 K)
 Standard Pressure $P_0 = 101.3\text{ kPa}$ (29.92 inHg)
 Standard Density $\rho_0 = 0.002377\text{ slug per cubic feet}$
2. ISA

Table 3.1 - ISA

| ALTITUDE | | TEMPERATURE | |
|----------|-------|-------------|-------|
| m | ft | °C | °F |
| 0 | 0 | 15.0 | 59.0 |
| 305 | 1000 | 13.0 | 55.4 |
| 610 | 2000 | 11.0 | 51.9 |
| 915 | 3000 | 9.1 | 48.3 |
| 1220 | 4000 | 7.1 | 44.7 |
| 1524 | 5000 | 5.1 | 41.2 |
| 3049 | 10000 | -4.8 | 23.3 |
| 4573 | 15000 | -14.7 | 5.5 |
| 6098 | 20000 | -24.6 | -12.3 |
| 7622 | 25000 | -34.5 | -30.2 |
| 9146 | 30000 | -44.4 | -48.0 |
| 11003 | 36089 | -56.5 | -69.7 |
| 12195 | 40000 | -56.5 | -69.7 |

NOTE: The performance data shown in this section must not be used for operations.

NOTE: For further information about performance, refer to AOM and AFM.

Tire speed limits are not applicable to this specific aircraft.

This section provides the following information:

- The payload x range charts.
- The takeoff field length charts.
- The landing field length charts.



NOTE: For other charts containing payload x ranges, takeoff field lengths and/or landing field lengths with conditions different from those presented in this section, Embraer should be contacted so that these charts can be obtained.

3.2. **PAYLOAD X RANGE**

The Payload x Range charts are based on the following conditions:

- CF34 - 10E engine models;
- Aircraft carrying passengers at 100 kg (220 lb) each one;
- Flight level 350, that represents the cruising altitude equal to 10668 m (35000 ft);
- Atmosphere according to ISA or ISA + 10 °C conditions;
- MTOW.



EFFECTIVITY: EMBRAER 190 STD ACFT MODEL
Payload x Range - ISA Conditions
Figure 3.1

PAYLOAD VS RANGE
 CF34 -10E5A, -10E5A1, -10E6A, -10E6A1 & -10E7 ENGINES
 FLIGHT LEVEL 370
 ISA
 RESERVE : 100 nm ALTERNATE + 45 min FLIGHT
 MTOW = 47790 kg (105359 lb)

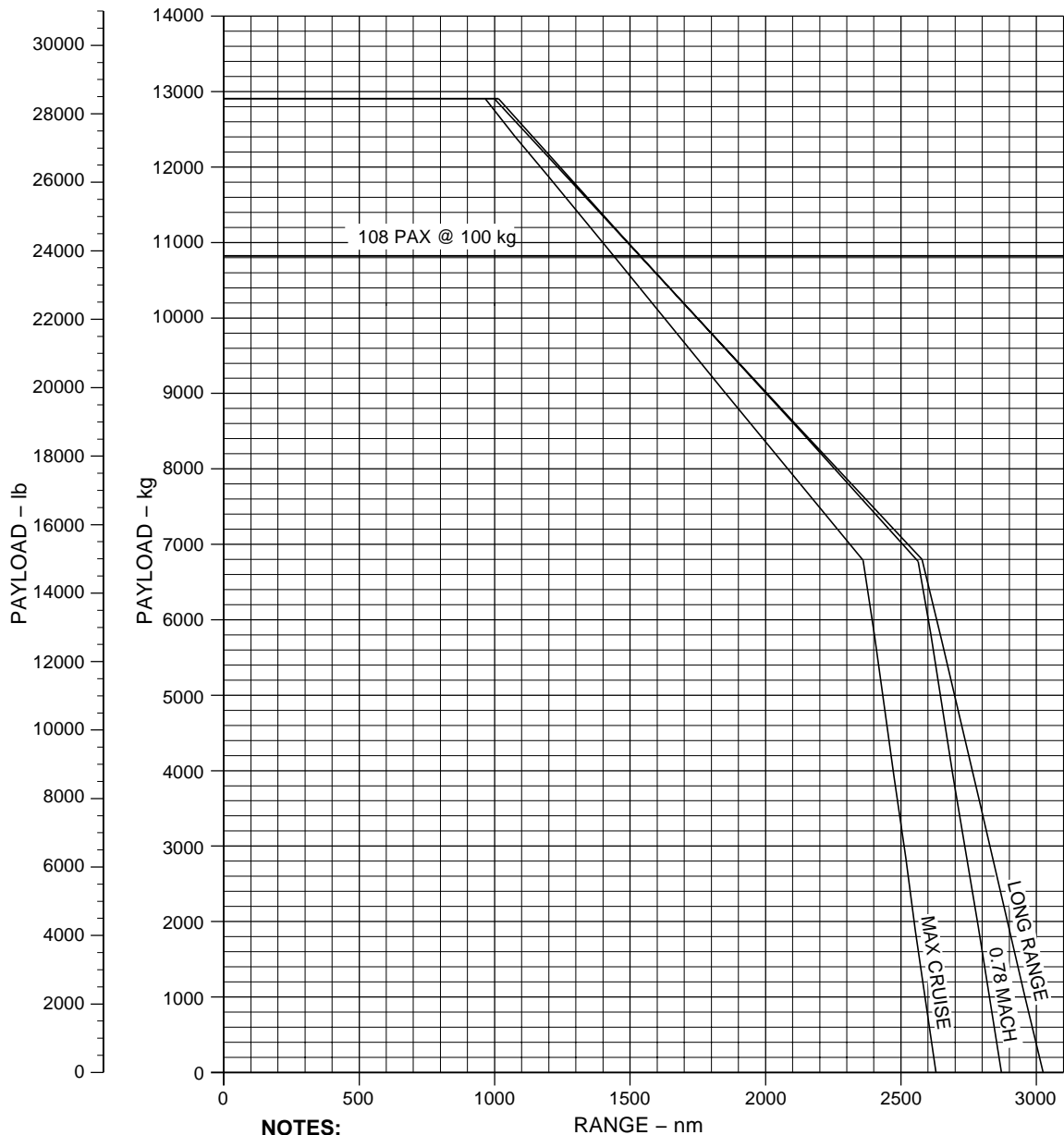
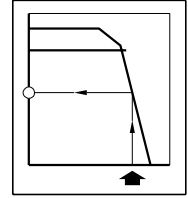

NOTES:
 MAX TAKEOFF WEIGHT - - - - - 47790 kg (105359 lb)
 MAX ZERO FUEL WEIGHT - - - - - 40800 kg (89948 lb)
 BASIC OPERATING WEIGHT - - - - - 27900 kg (61509 lb)
 MAX USABLE FUEL - - - - - 13100 kg (28880 lb)

EM170APM030030E.DGN



EFFECTIVITY: EMBRAER 190 STD ACFT MODEL

Payload x Range - ISA + 10 °C Conditions

Figure 3.2

PAYLOAD VS RANGE
 CF34 -10E5A, -10E5A1, -10E6A, -10E6A1 & -10E7 ENGINES
 FLIGHT LEVEL 370
 ISA + 10°C
 RESERVE : 100 nm ALTERNATE + 45 min FLIGHT
 MTOW = 47790 kg (105359 lb)

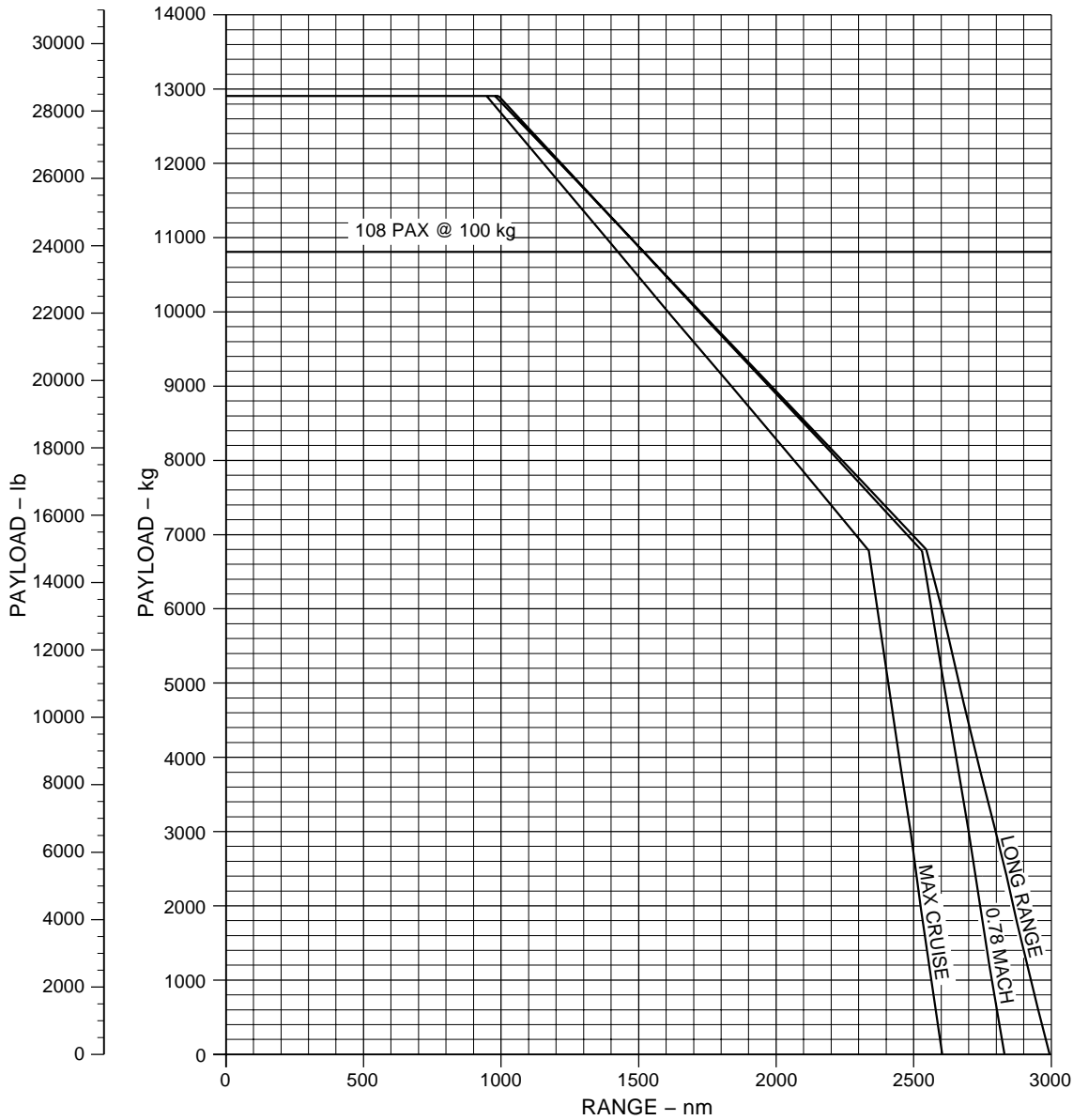
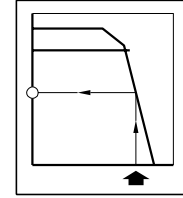

NOTES:

- MAX TAKEOFF WEIGHT - - - - - 47790 kg (105359 lb)
- MAX ZERO FUEL WEIGHT - - - - - 40800 kg (89948 lb)
- BASIC OPERATING WEIGHT - - - - - 27900 kg (61509 lb)
- MAX USABLE FUEL - - - - - 13100 kg (28880 lb)

EM170APM030031E.DGN



EFFECTIVITY: EMBRAER 190 LR ACFT MODEL

Payload x Range - ISA Conditions

Figure 3.3

PAYLOAD VS RANGE
 CF34 -10E5A, -10E5A1, -10E6A, -10E6A1 & -10E7 ENGINES
 FLIGHT LEVEL 370
 ISA
 RESERVE : 100 nm ALTERNATE + 45 min FLIGHT
 MTOW = 50300 kg (110893 lb)

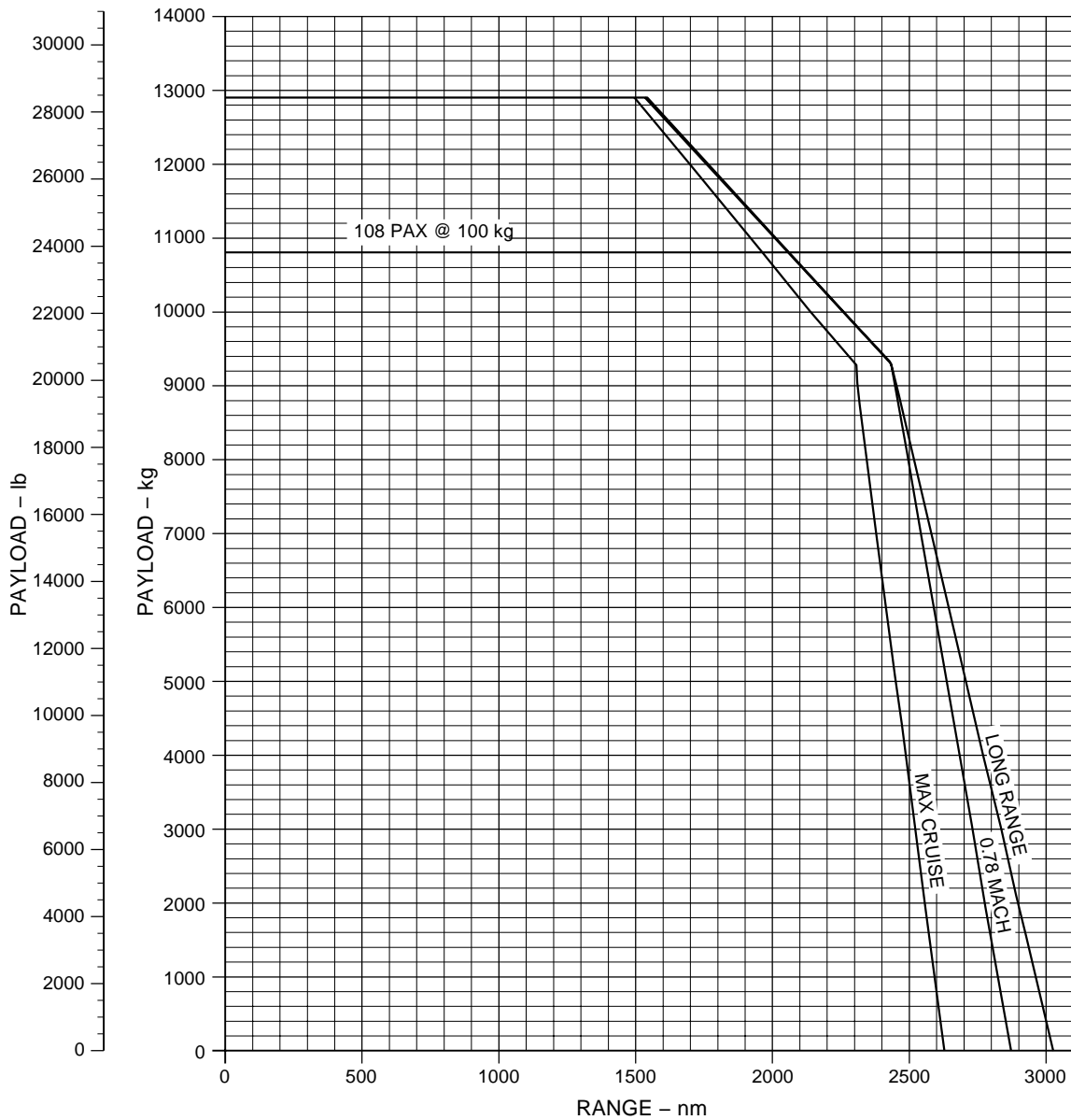
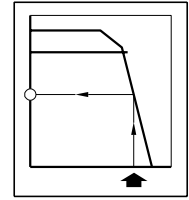

NOTES:

- MAX TAKEOFF WEIGHT - - - - - 50300 kg (110893 lb)
- MAX ZERO FUEL WEIGHT - - - - - 40800 kg (89949 lb)
- BASIC OPERATING WEIGHT - - - - - 27900 kg (61509 lb)
- MAX USABLE FUEL - - - - - 13100 kg (28880 lb)

EM170APM030032D.DGN



EFFECTIVITY: EMBRAER 190 LR ACFT MODEL

Payload x Range - ISA + 10 °C Conditions

Figure 3.4

PAYLOAD VS RANGE
 CF34 -10E5A, -10E5A1, -10E6A, -10E6A1 & -10E7 ENGINES
 FLIGHT LEVEL 370
 ISA + 10°C
 RESERVE : 100 nm ALTERNATE + 45 min FLIGHT
 MTOW = 50300 kg (110893 lb)

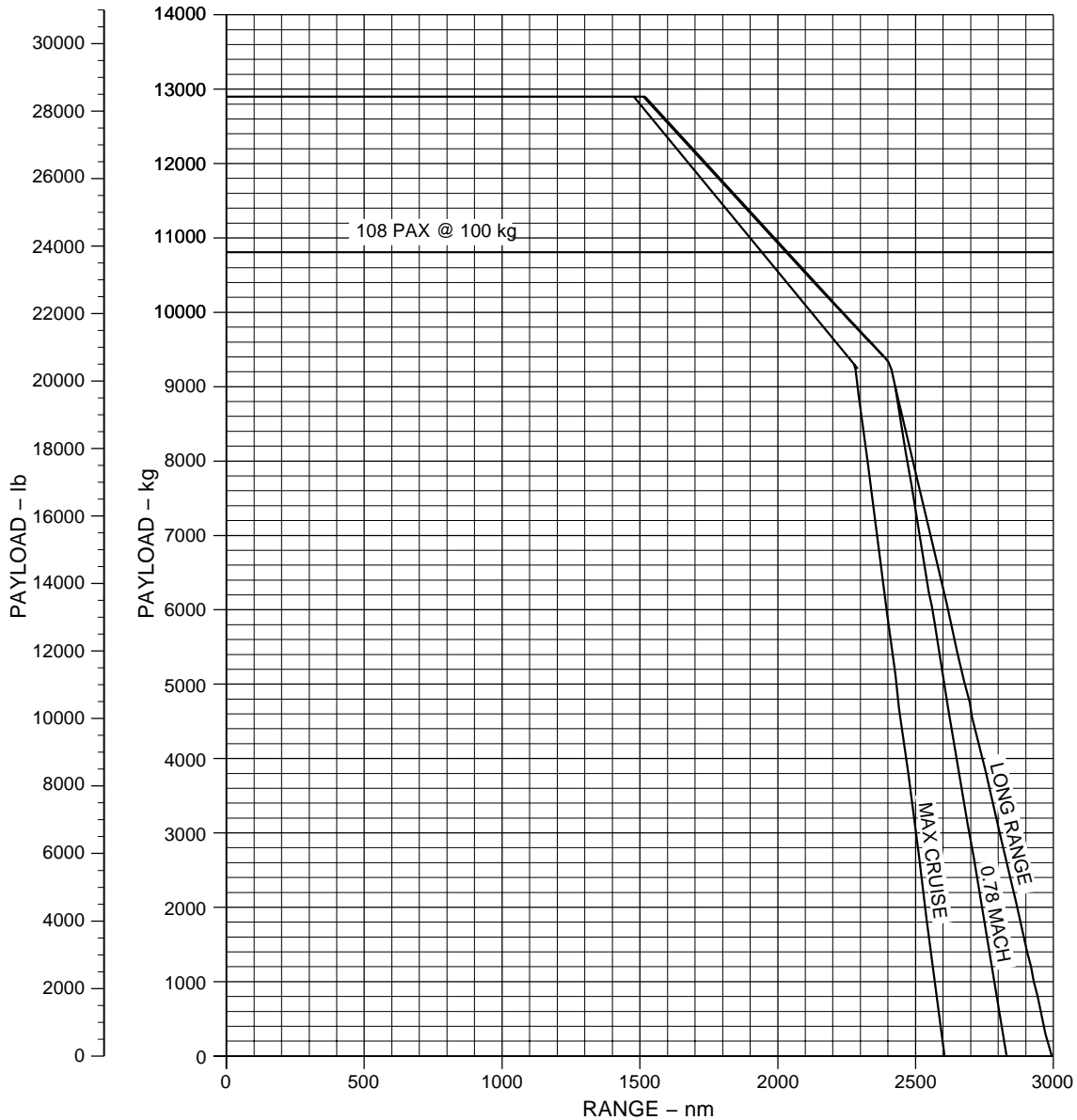
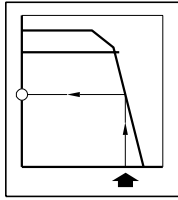

NOTES:

- MAX TAKEOFF WEIGHT - - - - - 50300 kg (110893 lb)
- MAX ZERO FUEL WEIGHT - - - - - 40800 kg (89949 lb)
- BASIC OPERATING WEIGHT - - - - - 27900 kg (61509 lb)
- MAX USABLE FUEL - - - - - 13100 kg (28880 lb)

EM170APM030033D.DGN



EFFECTIVITY: EMBRAER 190 AR ACFT MODEL

Payload x Range - ISA Conditions

Figure 3.5

PAYLOAD VS RANGE
 CF34 -10E5A, -10E5A1, -10E6A, -10E6A1 & -10E7 ENGINES
 FLIGHT LEVEL 370
 ISA
 RESERVE : 100 nm ALTERNATE + 45 min FLIGHT
 MTOW = 51800 kg (114199 lb)

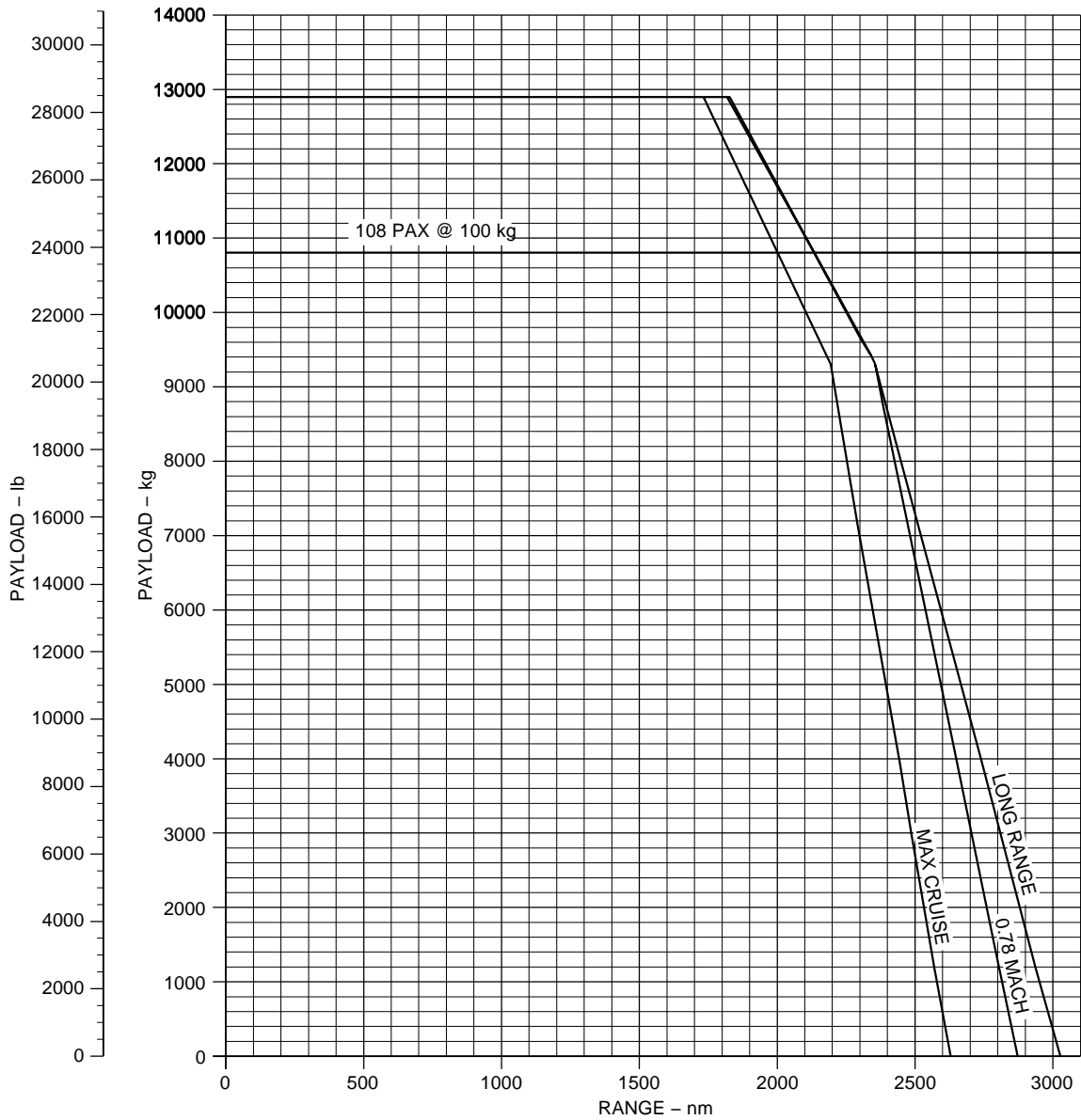
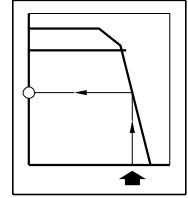

NOTES:

- MAX TAKEOFF WEIGHT - - - - - 51800 kg (114199 lb)
- MAX ZERO FUEL WEIGHT - - - - - 40900 kg (90169 lb)
- BASIC OPERATING WEIGHT - - - - - 27900 kg (61509 lb)
- MAX USABLE FUEL - - - - - 13100 kg (28880 lb)

EM170APM030060C.DGN



EFFECTIVITY: EMBRAER 190 AR ACFT MODEL

Payload x Range - ISA + 10 °C Conditions

Figure 3.6

PAYLOAD VS RANGE
 CF34 -10E5A, -10E5A1, -10E6A, -10E6A1 & -10E7 ENGINES
 FLIGHT LEVEL 370
 ISA+10
 RESERVE : 100 nm ALTERNATE + 45 min FLIGHT
 MTOW = 51800 kg (114199 lb)

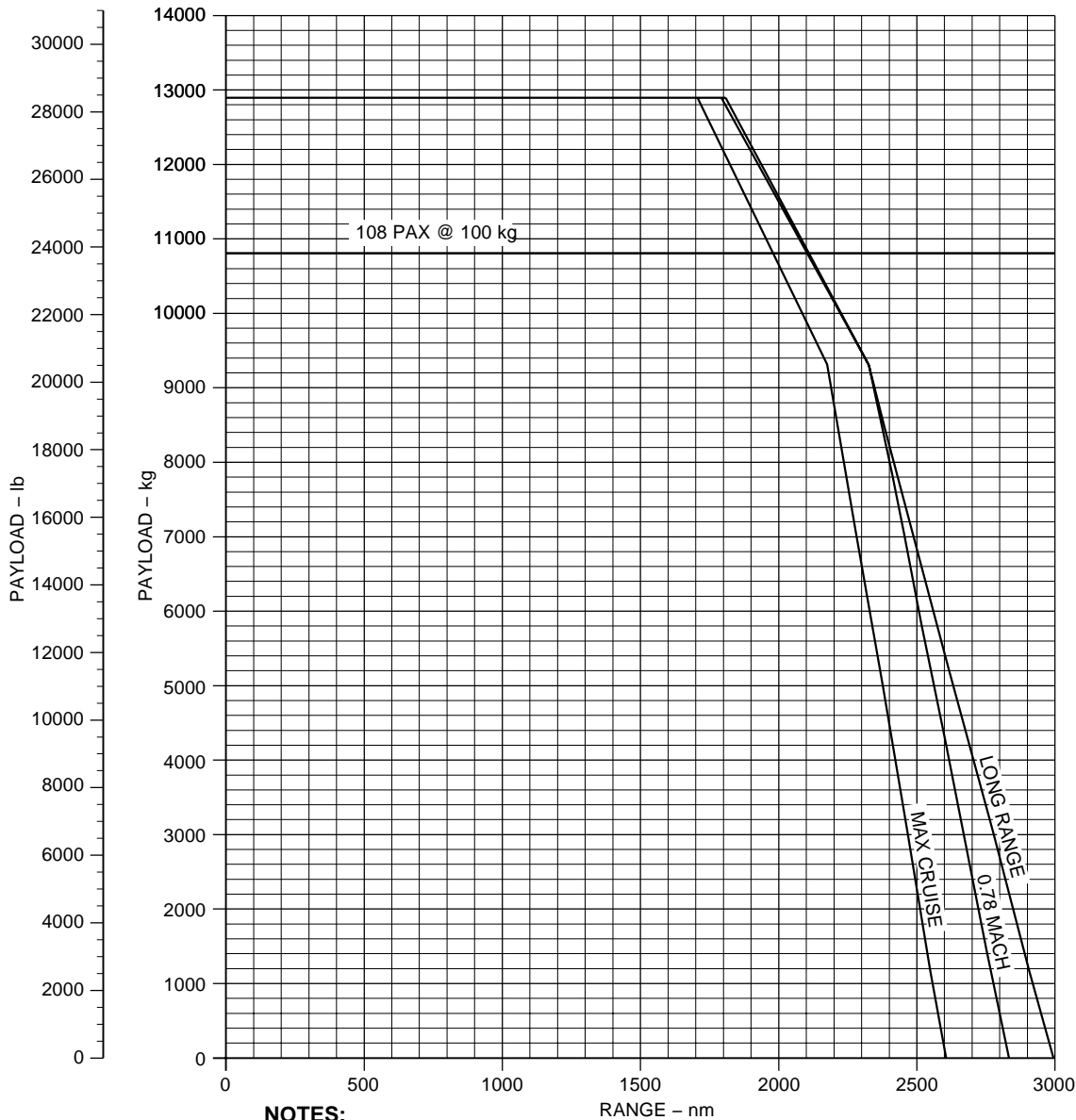
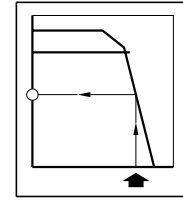

NOTES:

- MAX TAKEOFF WEIGHT - - - - - 51800 kg (114199 lb)
- MAX ZERO FUEL WEIGHT - - - - - 40900 kg (90169 lb)
- BASIC OPERATING WEIGHT - - - - - 27900 kg (61509 lb)
- MAX USABLE FUEL - - - - - 13100 kg (28880 lb)

EM170APM030061C.DGN

**3.3. TAKEOFF FIELD LENGTHS**

The takeoff performance is based on the requirements of JAR 25, Change 14, plus amendment 25/96/1.

The takeoff field lengths charts provide data about the maximum takeoff weights for compliance with the operating regulations relating to takeoff field lengths.

Data are presented according to the following associated conditions:

- CF34 - 10E engine models;
- Takeoff Mode: 1;
- ATTCS positioning: ON and OFF;
- Flaps setting position: 1, 2 and 4;
- Pavement conditions: dry, hard paved and level runway surface with no obstacles;
- Zero wind and atmosphere according to ISA or ISA + 10 °C conditions;
- Pack OFF: No engine bleed extraction for air conditioning packs was considered in the takeoff and landing charts.



EFFECTIVITY: ALL

Takeoff Field Lengths - ISA Conditions

Figure 3.7

TAKEOFF FIELD LENGTH
 CF 34-10E5 & -10E6 ENGINE @T/O-1 MODE
 ATTCS OFF / ECS OFF
 DRY, SMOOTH, HARD PAVED AND LEVEL RUNWAY
 ISA

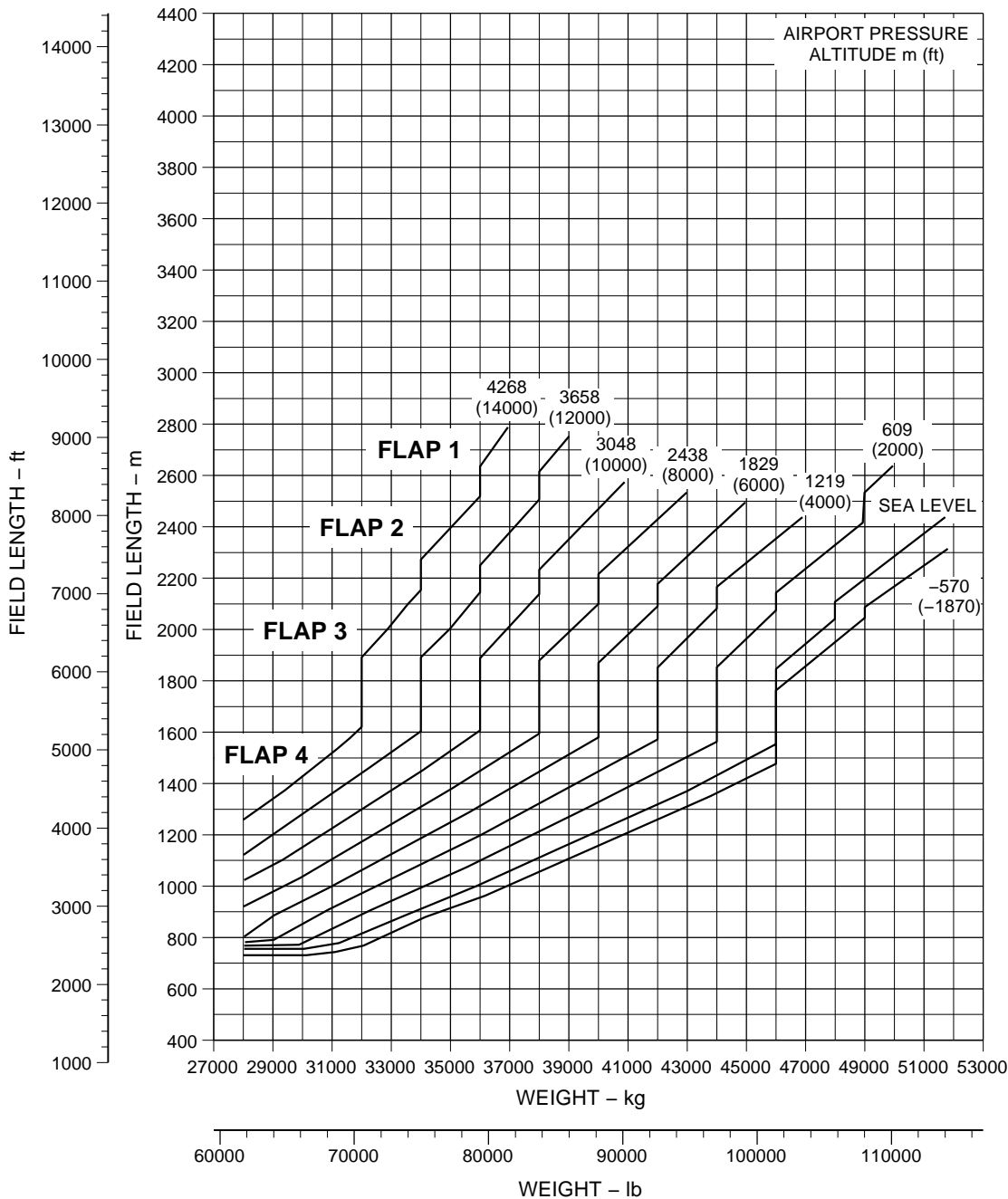
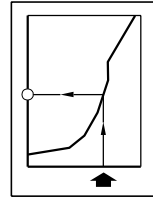

EM170APM030036E.DGN



EFFECTIVITY: ALL

Takeoff Field Lengths - ISA + 15 °C Conditions

Figure 3.8

TAKEOFF FIELD LENGTH
 CF34-10E5 & -10E6 Engines @ T/O-1 MODE
 ATTCS OFF / ECS OFF
 DRY, SMOOTH, HARD PAVED AND LEVEL RUNWAY
 ISA + 15°C

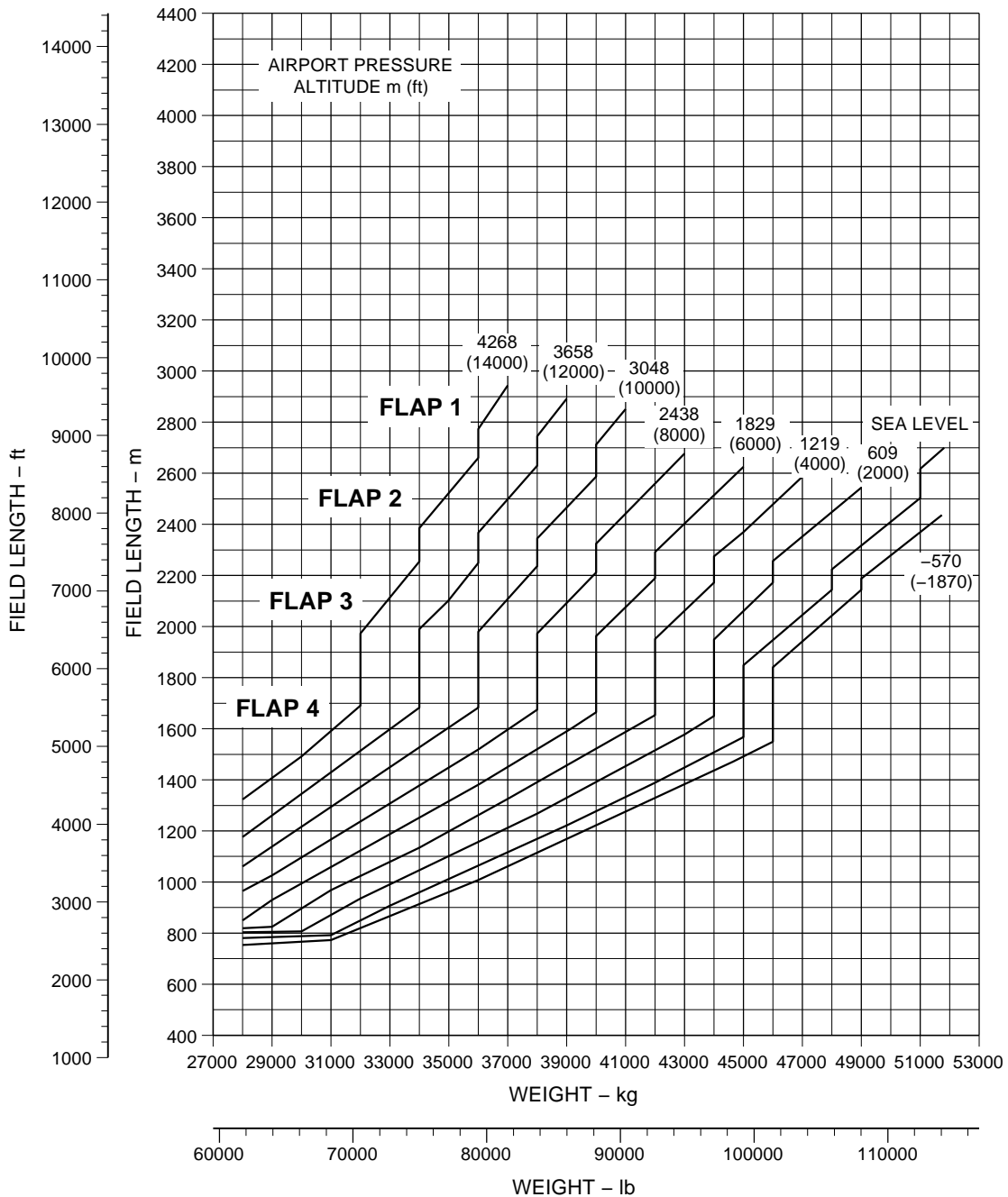
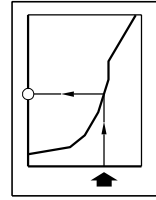

EM170APM030037E.DGN



EFFECTIVITY: ALL

Takeoff Field Lengths - ISA Conditions

Figure 3.9

TAKEOFF FIELD LENGTH
 CF34-10E5 & -10E6 Engines @ T/O-1 MODE
 ATTCS ON / ECS OFF
 DRY, SMOOTH, HARD PAVED AND LEVEL RUNWAY
 ISA

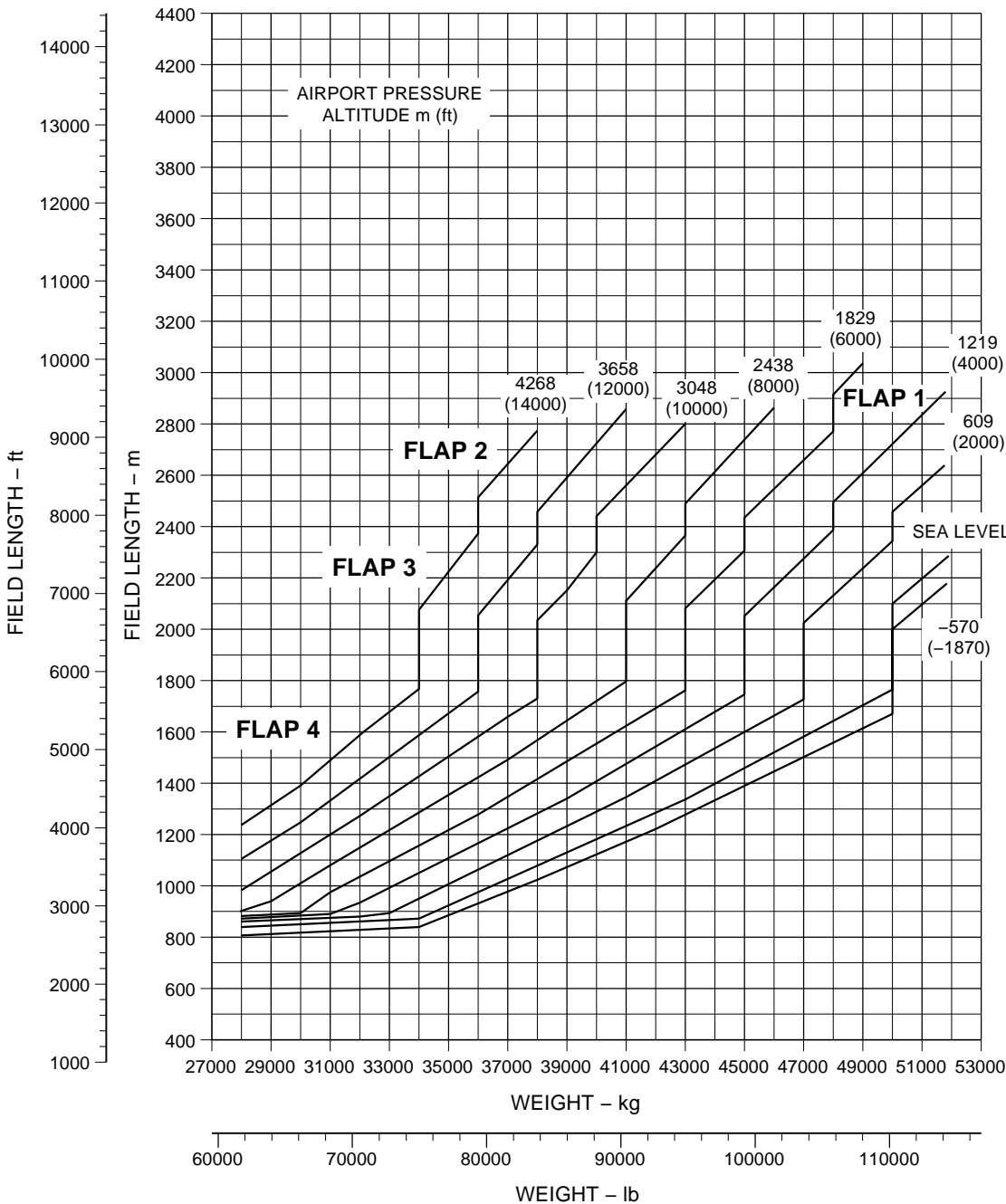
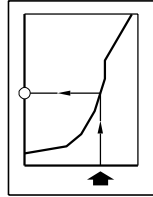

EM170APM030038E.DGN



EFFECTIVITY: ALL

Takeoff Field Lengths - ISA + 15 °C Conditions

Figure 3.10

TAKEOFF FIELD LENGTH
 CF34-10E5 & -10E6 Engines @ T/O-1 MODE
 ATTCs ON / ECS OFF
 DRY, SMOOTH, HARD PAVED AND LEVEL RUNWAY
 ISA + 15°C

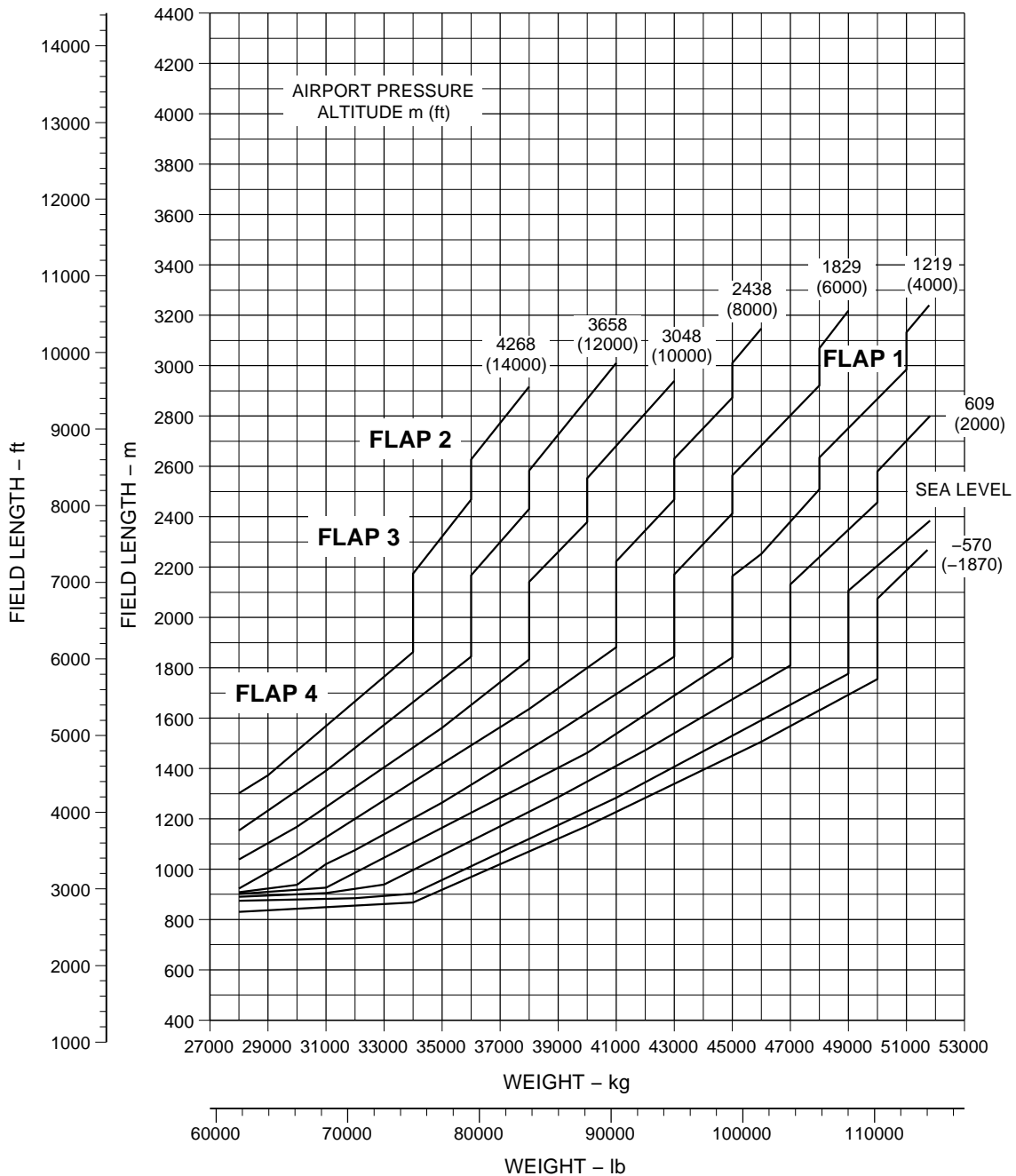
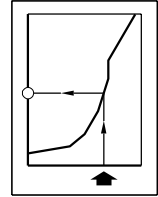

EM170APM030039E.DGN



EFFECTIVITY: ALL

Takeoff Field Lengths - ISA Conditions

Figure 3.11

TAKEOFF FIELD LENGTH
 CF34-10E5A1 & 10E6A1 ENGINES@T/O-1 MODE
 DRY, SMOOTH, HARD PAVED AND LEVEL RUNWAY
 ISA

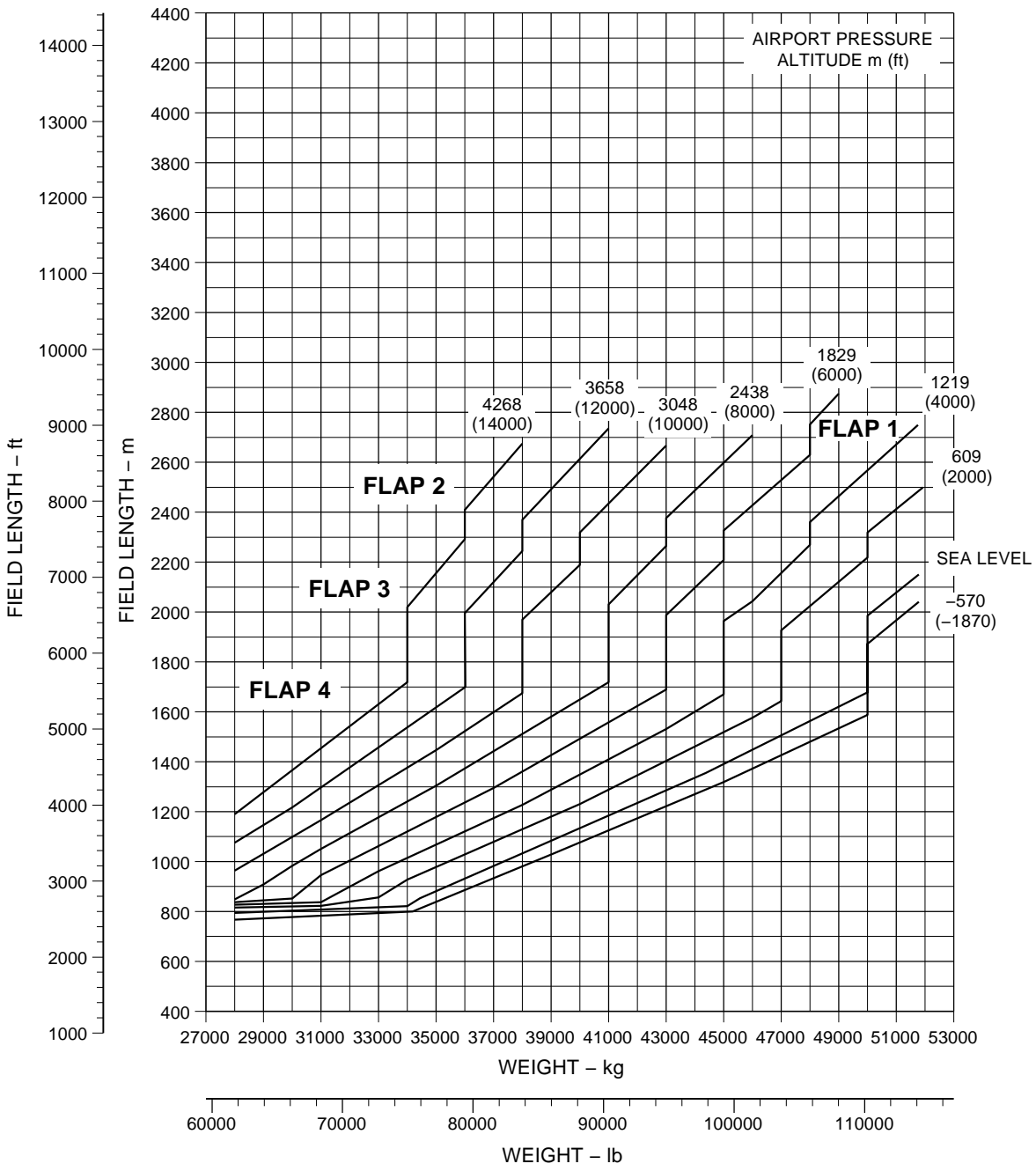
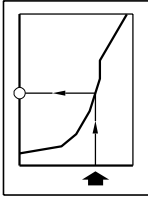

EM170APM030034D.DGN



EFFECTIVITY: ALL

Takeoff Field Lengths - ISA + 15 °C Conditions

Figure 3.12

TAKEOFF FIELD LENGTH

CF34-10E5A1 & 10E6A1 ENGINES@T/O-1 MODE
 DRY, SMOOTH, HARD PAVED AND LEVEL RUNWAY
 ISA + 15°C

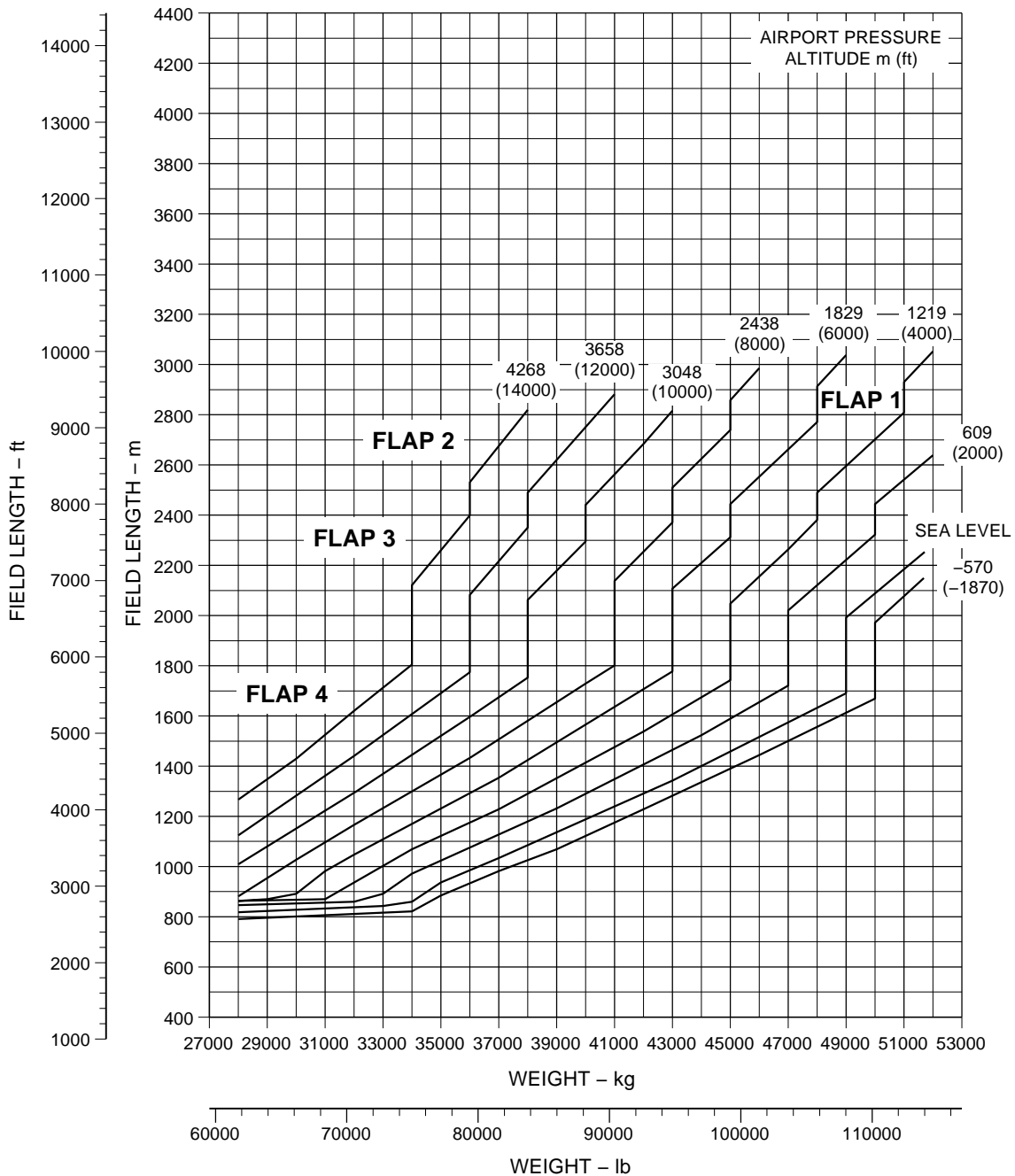
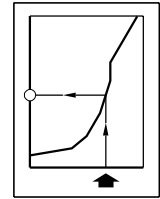

EM170APM030035D.DGN



EFFECTIVITY: ALL

Takeoff Field Lengths - ISA Conditions

Figure 3.13

TAKEOFF FIELD LENGTH
 CF 34-10E7 ENGINE @ T/O-1 MODE
 ATTCS ON / ECS OFF
 DRY, SMOOTH, HARD PAVED AND LEVEL RUNWAY
 ISA

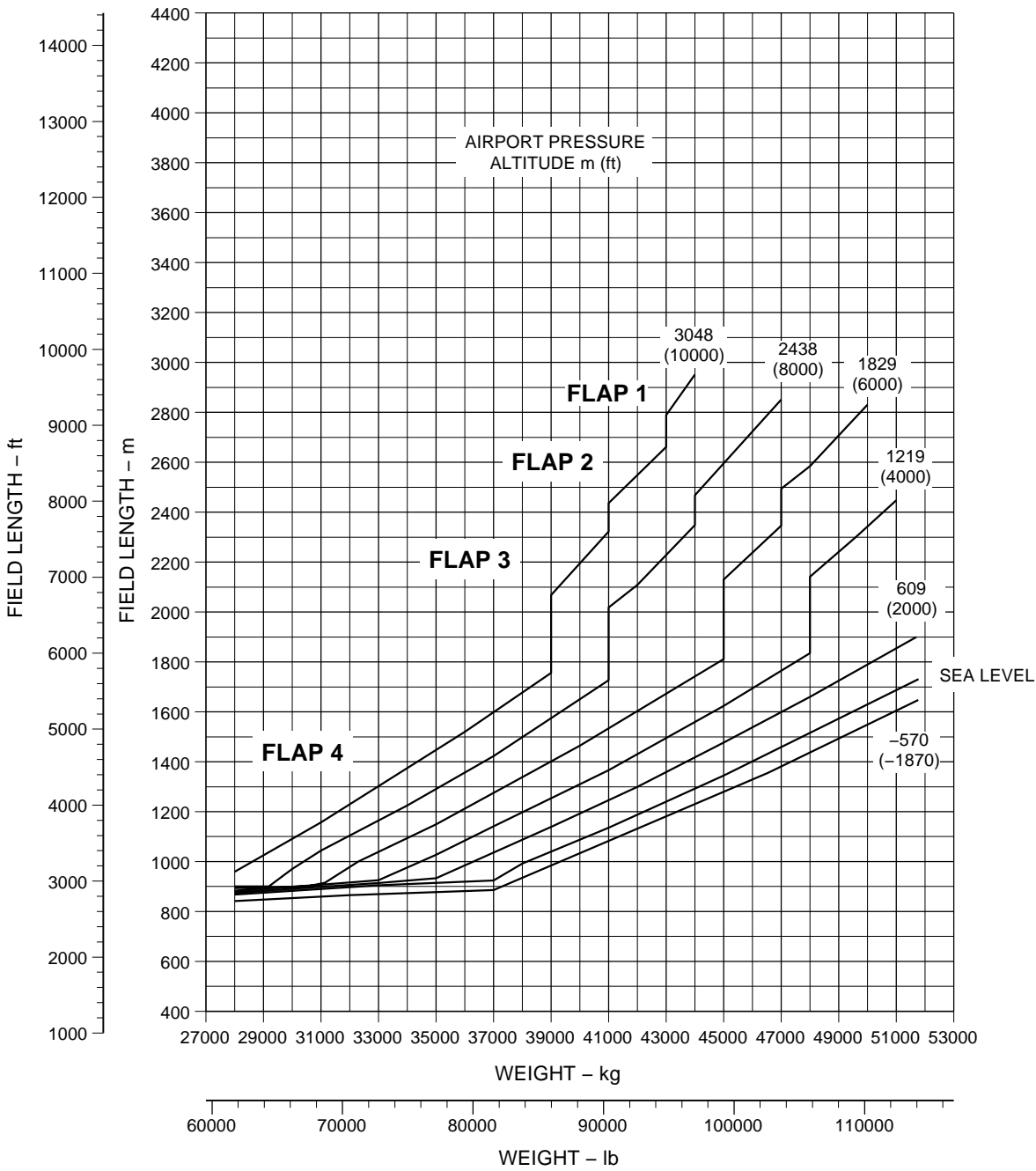
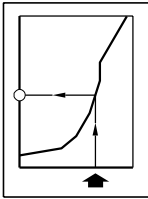

EM170APM030040D.DGN



EFFECTIVITY: ALL

Takeoff Field Lengths - ISA + 15 °C Conditions

Figure 3.14

TAKEOFF FIELD LENGTH
 CF 34-10E7 ENGINE @ T/O-1 MODE
 ATTCS ON / ECS OFF
 DRY, SMOOTH, HARD PAVED AND LEVEL RUNWAY
 ISA + 15°C

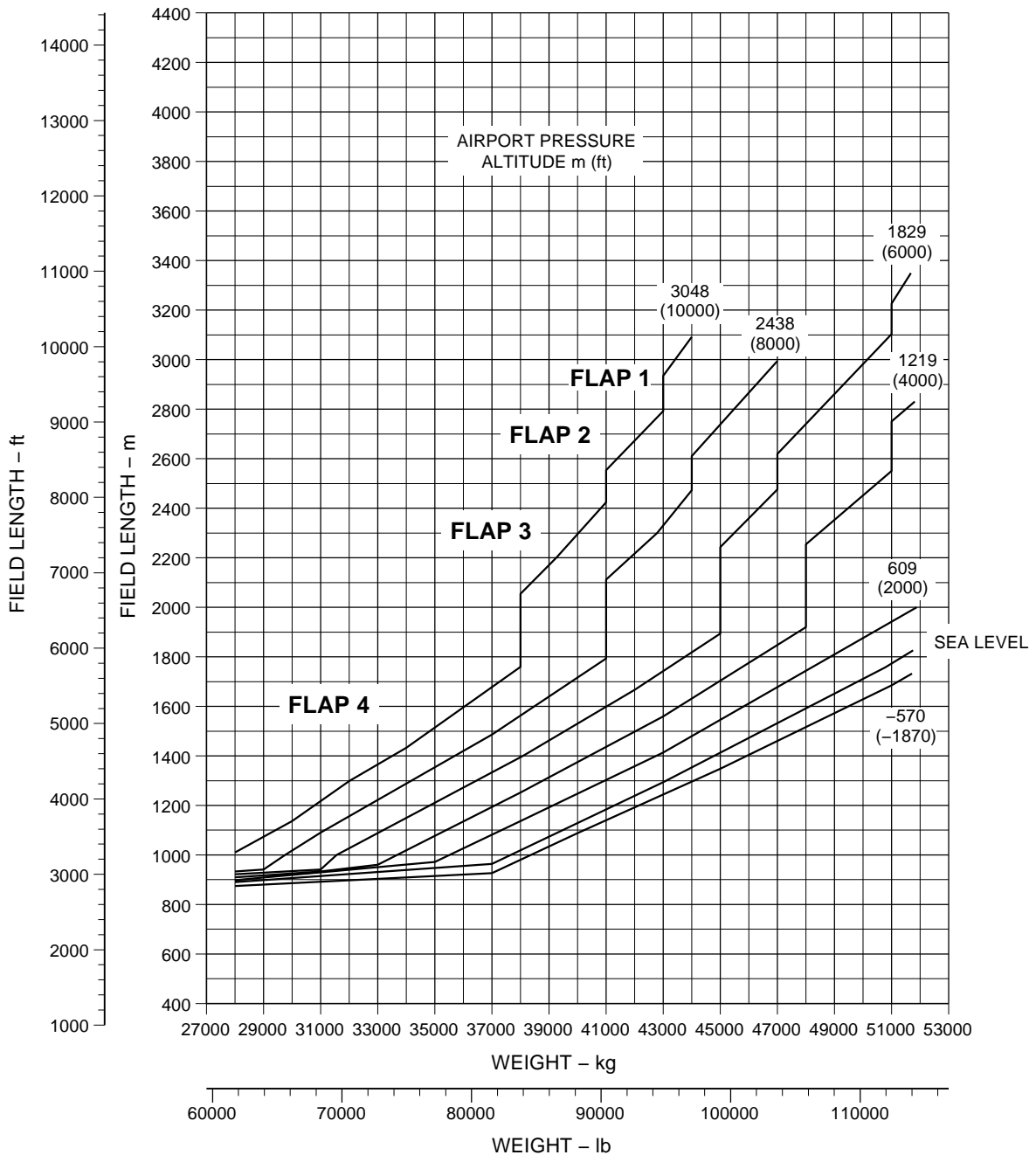
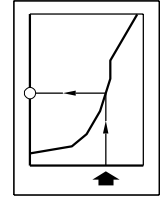

EM170APM030041D.DGN



EFFECTIVITY: ALL

Takeoff Field Lengths - ISA Conditions

Figure 3.15

TAKEOFF FIELD LENGTH
 CF 34-10E7 ENGINE @ T/O-1 MODE
 ATTCS OFF / ECS OFF
 DRY, SMOOTH, HARD PAVED AND LEVEL RUNWAY
 ISA

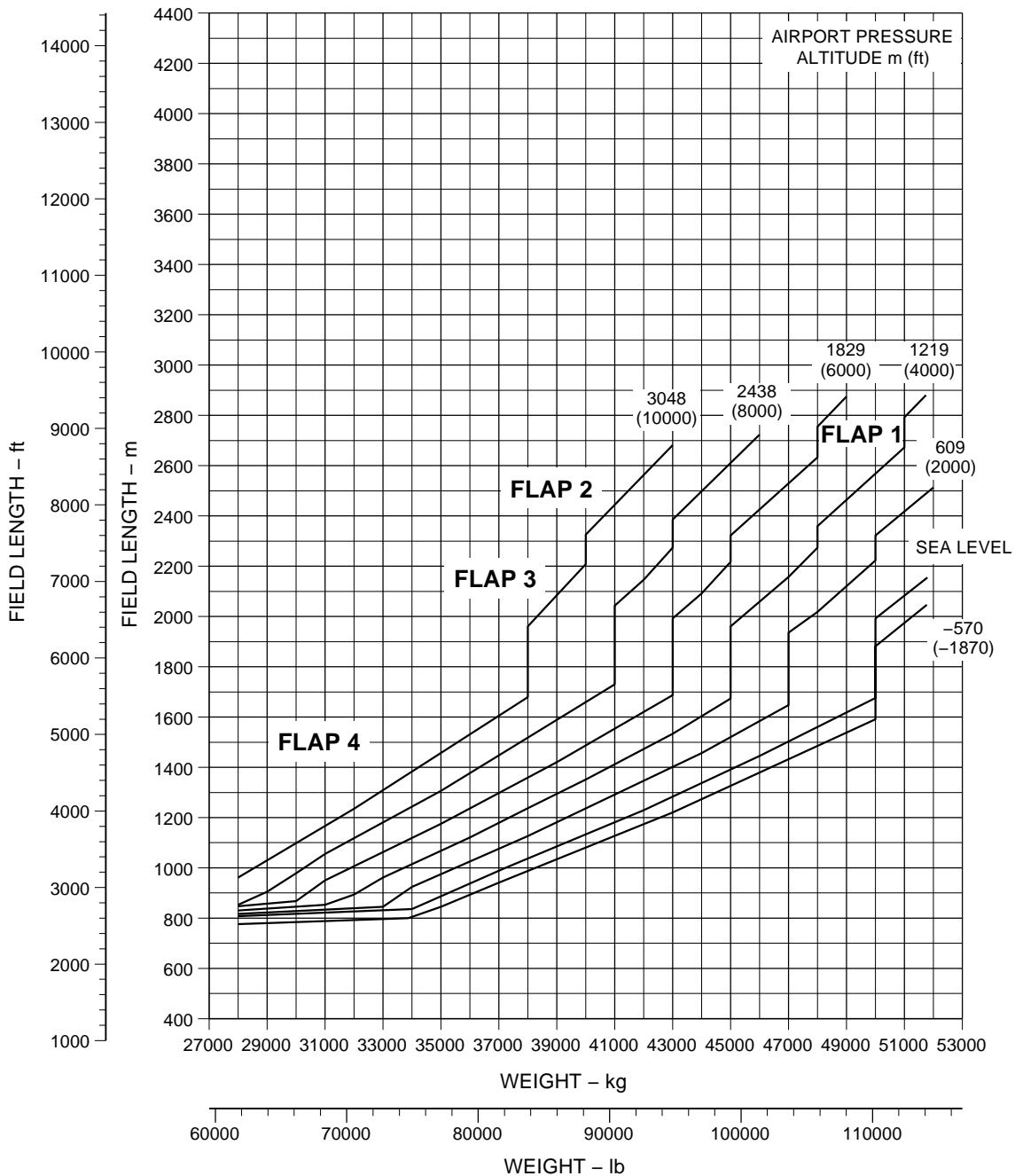
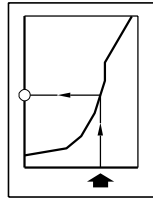

EM170APM030105A.DGN



EFFECTIVITY: ALL

Takeoff Field Lengths - ISA + 15 °C Conditions

Figure 3.16

TAKEOFF FIELD LENGTH
 CF 34-10E7 ENGINE @T/O-1 MODE
 ATTCS OFF / ECS OFF
 DRY, SMOOTH, HARD PAVED AND LEVEL RUNWAY
 ISA+15

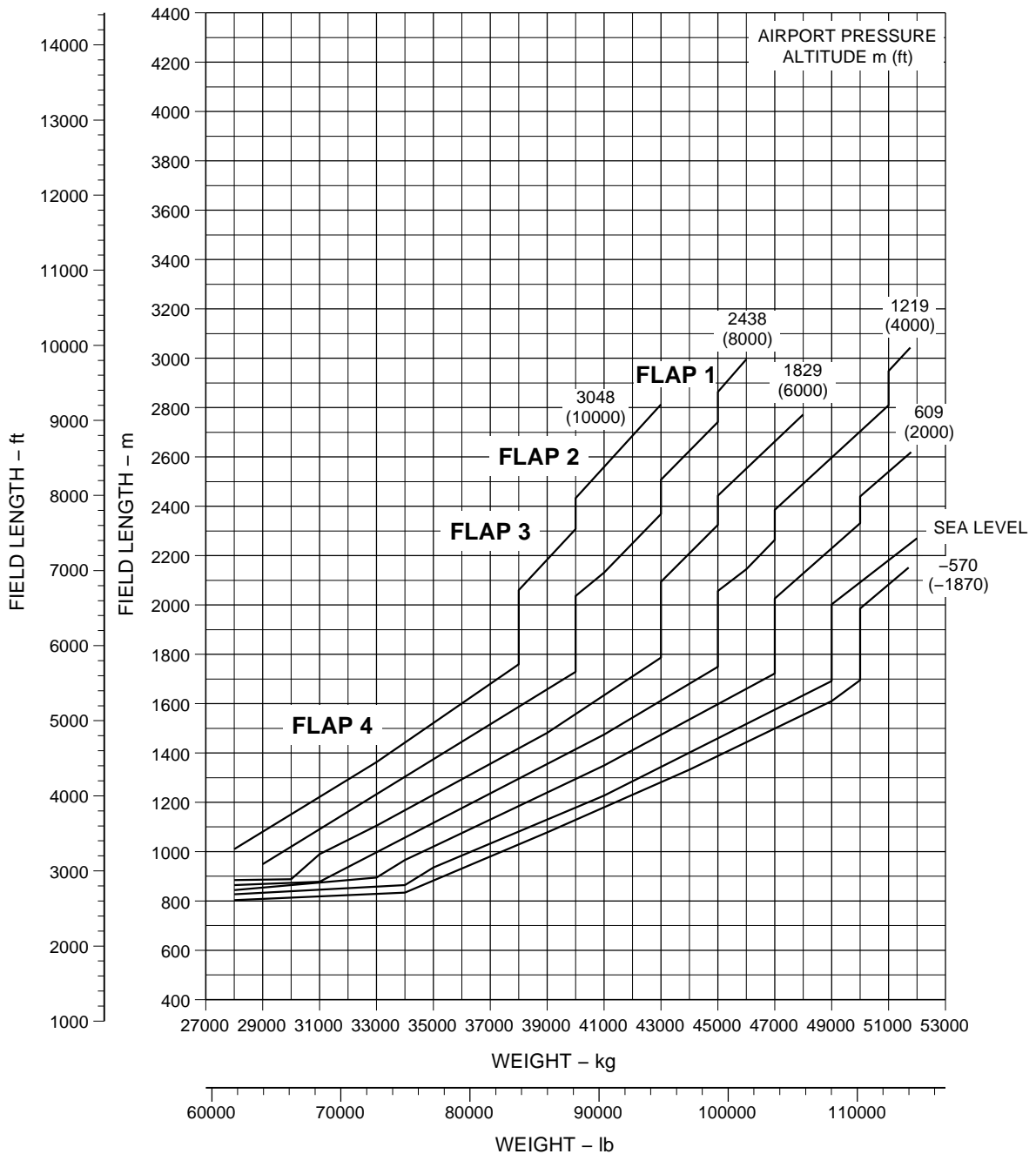
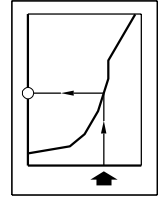

EM170APM030106A.DGN

**3.4. LANDING FIELDS LENGTHS**

The landing field lengths charts provide data about the maximum landing weights for compliance with the operating regulations relating to landing field lengths.

Data is presented according to the following associated conditions:

- Landing gear: down;
- Flaps setting position: 5 or full;
- Pavement conditions: dry, hard paved and level runway surface with no obstacles;
- Zero wind and atmosphere according to ISA conditions;
- Pack OFF: No engine bleed extraction for air conditioning packs was considered in the takeoff and landing charts.



EFFECTIVITY: EASA-CERTIFIED ACFT
Landing Field Lengths - Flaps 5
Figure 3.17

LANDING FIELD LENGTH
CF 34-10E5-10E5A1-10E6 & -10E6A1 ENGINES
DRY, SMOOTH, HARD PAVED AND LEVEL RUNWAY
FLAP 5
ISA

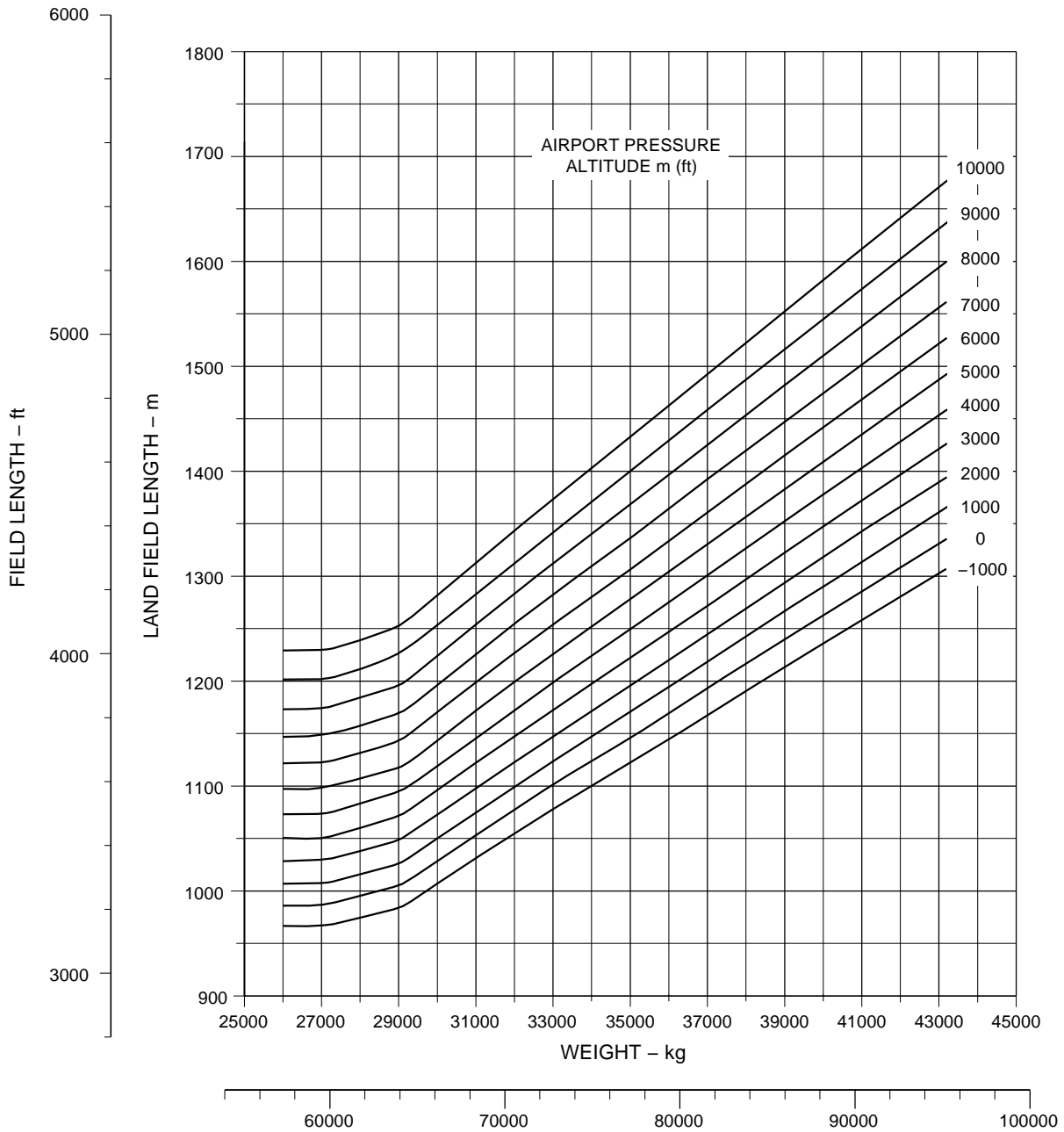
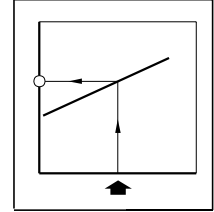

EM170APM030046C.DGN



EFFECTIVITY: EASA-CERTIFIED ACFT
Landing Field Lengths - Flaps Full
Figure 3.18

LANDING FIELD LENGTH
CF34-10E5-10E5A1-10E6 & -10E6A1 ENGINES
DRY, SMOOTH, HARD PAVED AND LEVEL RUNWAY
FLAP FULL
ISA

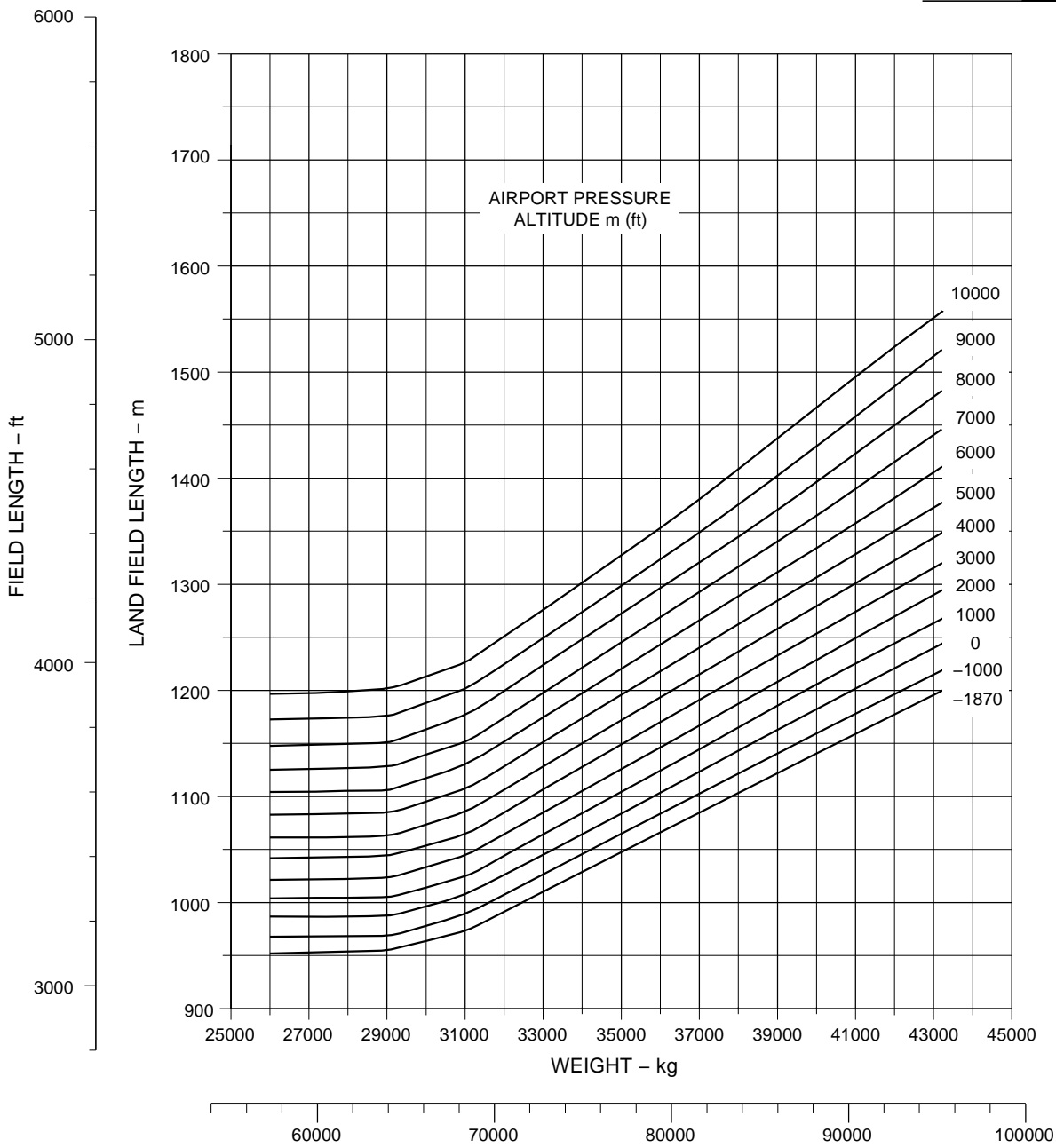
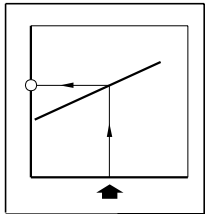

EM170APM030047C.DGN



EFFECTIVITY: EASA-CERTIFIED ACFT
Landing Field Lengths - Flaps 5
Figure 3.19

LANDING FIELD LENGTH
CF 34-10E7 ENGINE
DRY, SMOOTH, HARD PAVED AND LEVEL RUNWAY
FLAP 5
ISA

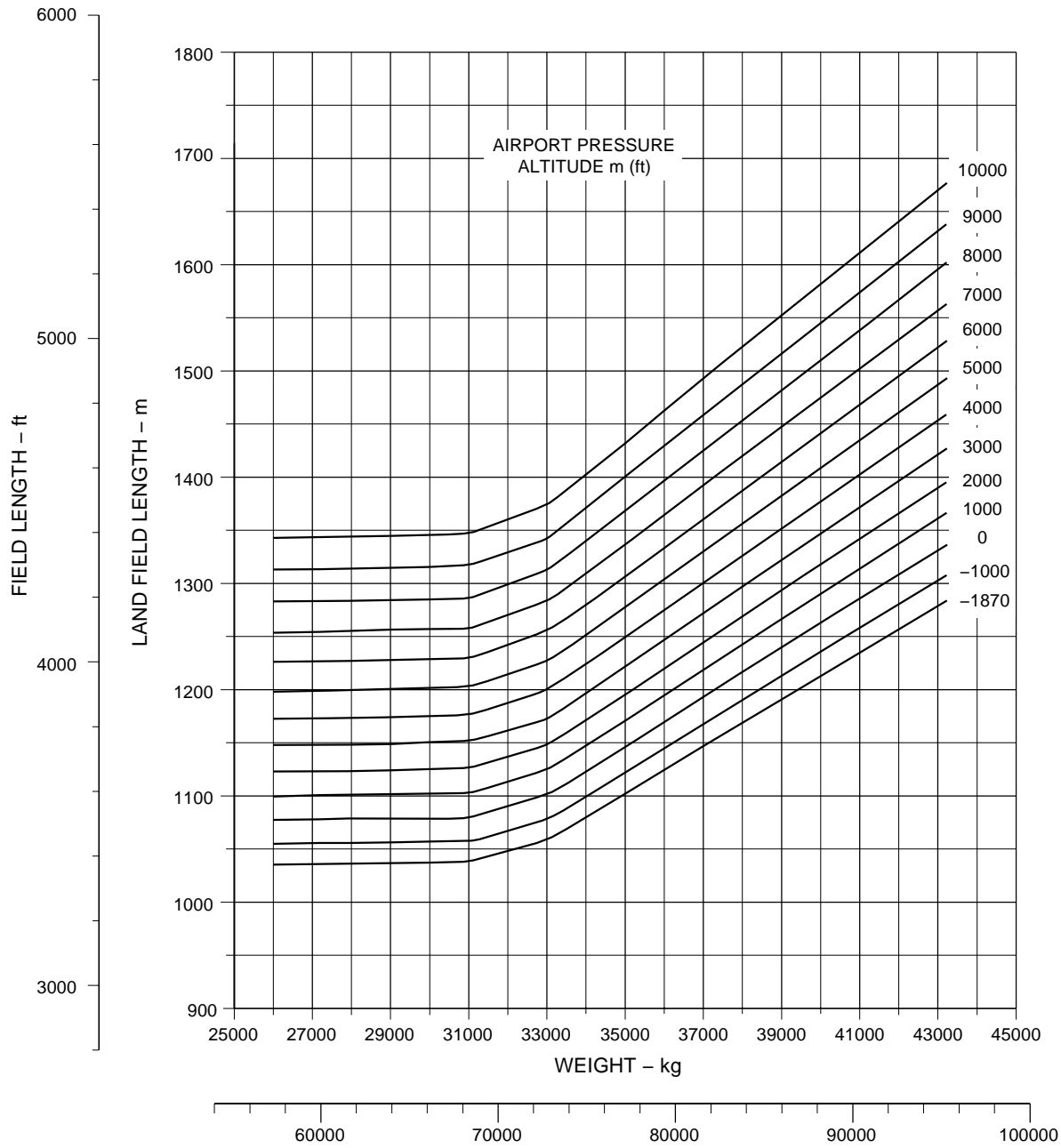
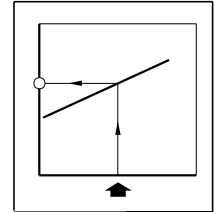

EM170APM030062B.DGN



EFFECTIVITY: EASA-CERTIFIED ACFT
Landing Field Lengths - Flaps Full
Figure 3.20

LANDING FIELD LENGTH
CF 34-10E7 ENGINE
DRY, SMOOTH, HARD PAVED AND LEVEL RUNWAY
FLAP FULL
ISA

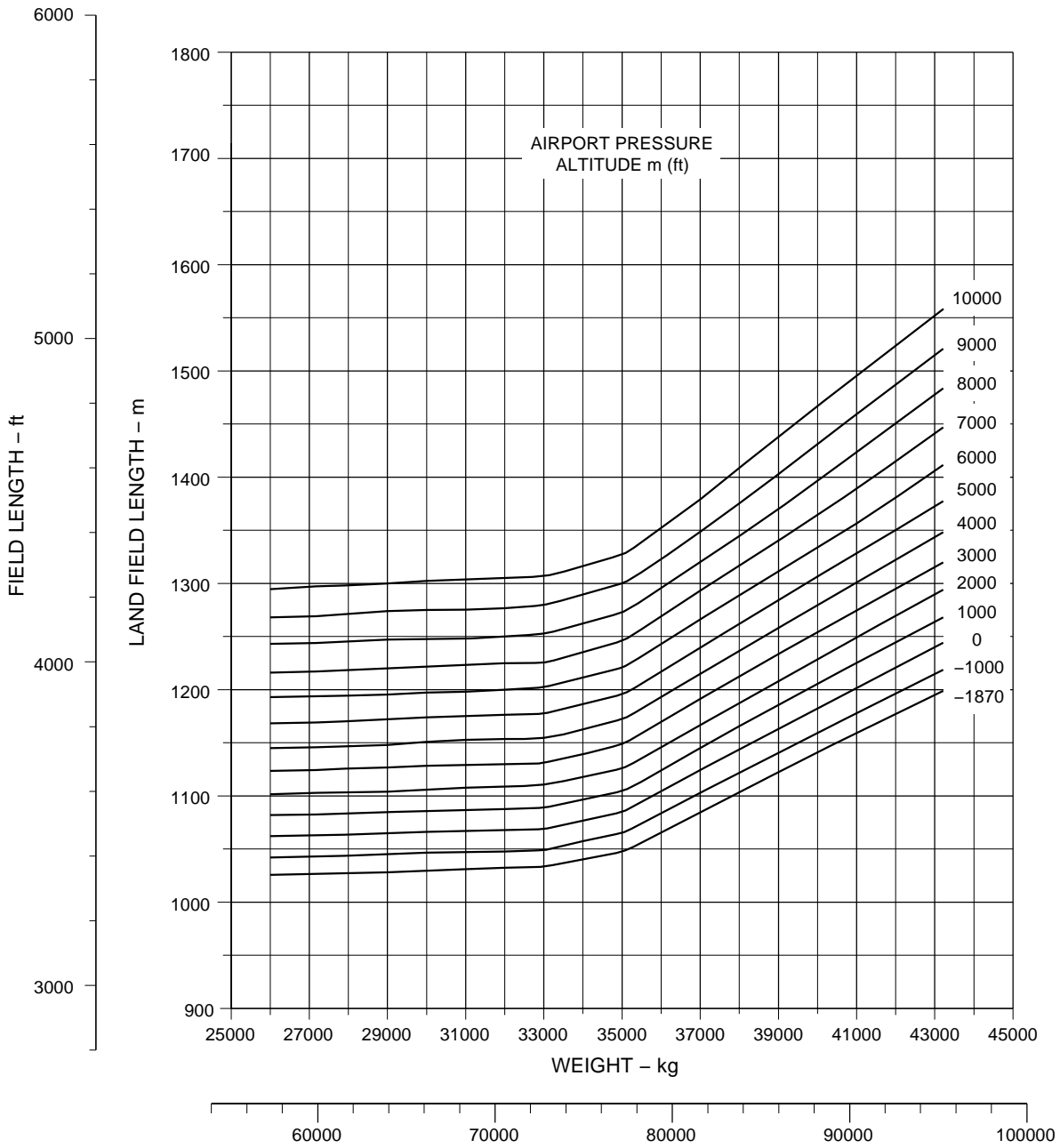
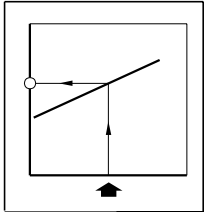

EM170APM030063B.DGN



EFFECTIVITY: FAA-CERTIFIED ACFT
Landing Field Lengths - Flaps 5
Figure 3.21

LANDING FIELD LENGTH
CF 34-10E5-10E5A1-10E6 & -10E6A1 ENGINES
DRY, SMOOTH, HARD PAVED AND LEVEL RUNWAY
FLAP 5
ISA

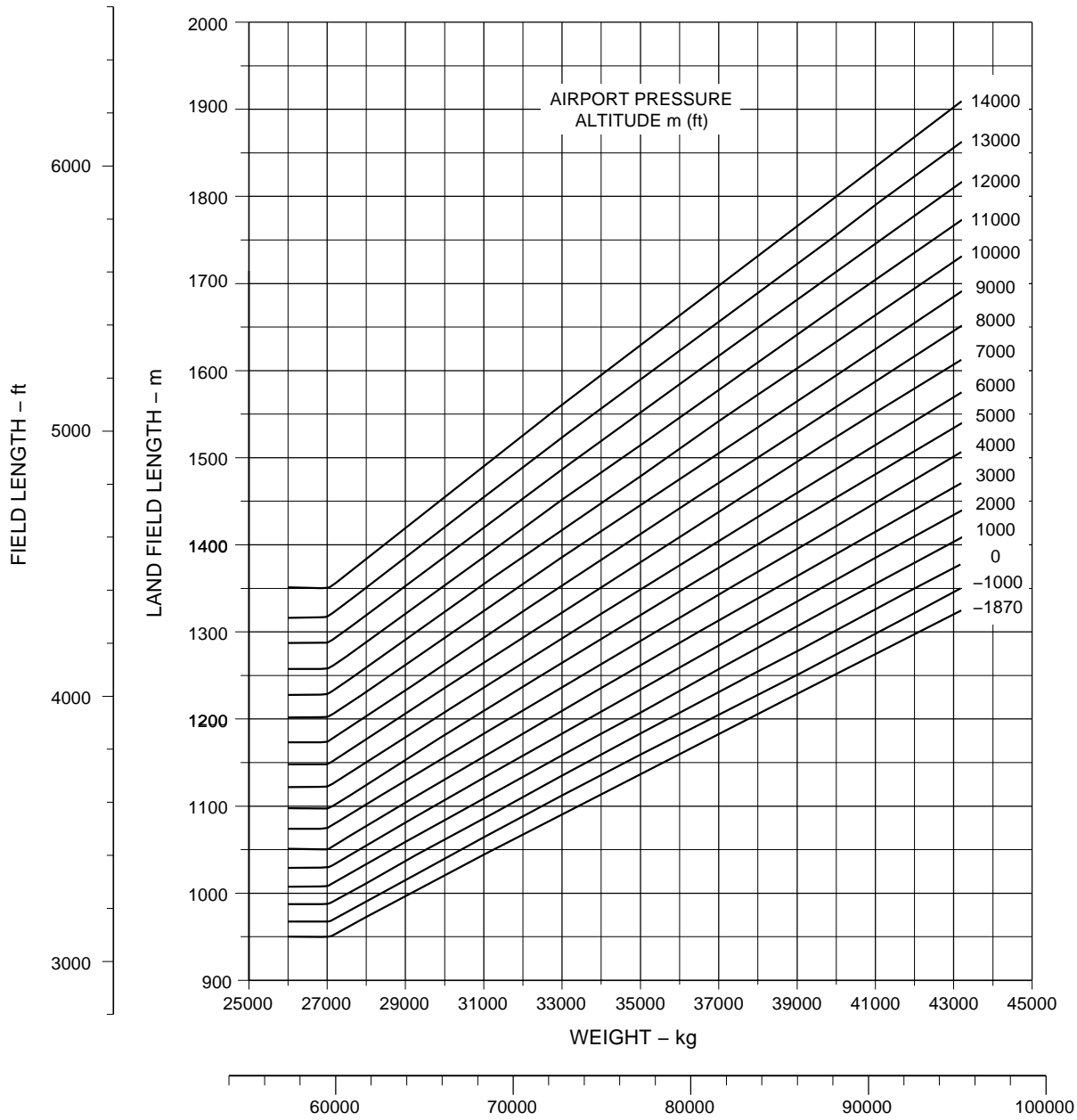
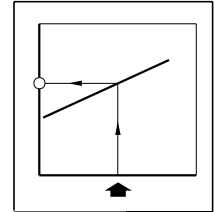

EM170APM030017A.DGN



EFFECTIVITY: FAA-CERTIFIED ACFT

Landing Field Lengths - Flaps Full

Figure 3.22

LANDING FIELD LENGTH
 CF 34-10E5-10E5A1-10E6 & -10E6A1 ENGINES
 DRY, SMOOTH, HARD PAVED AND LEVEL RUNWAY
 FLAP FULL
 ISA

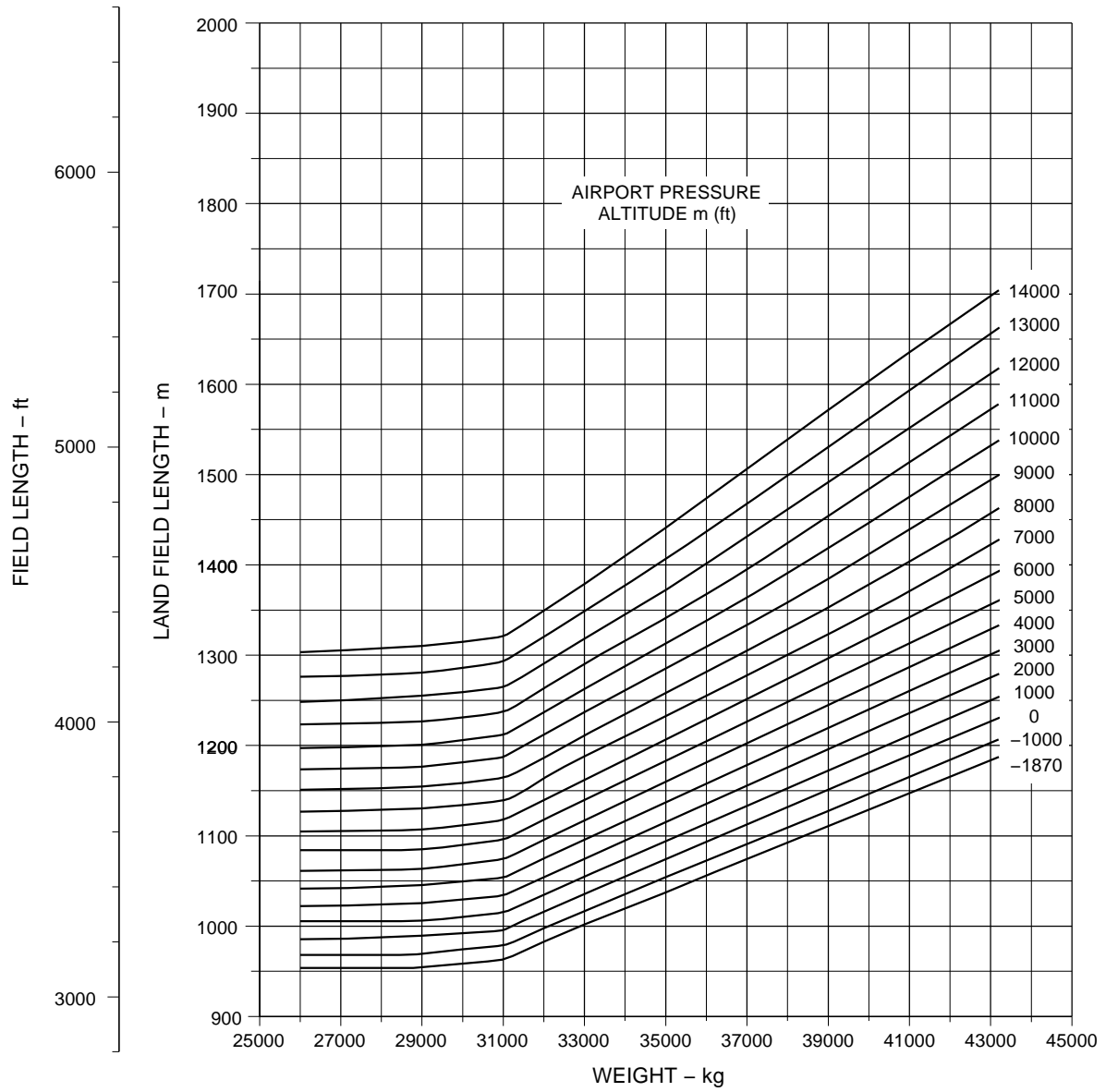
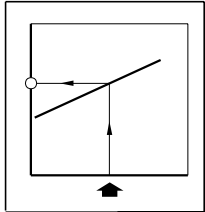

EM170APM030018A.DGN



EFFECTIVITY: FAA-CERTIFIED ACFT
Landing Field Lengths - Flaps 5
Figure 3.23

LANDING FIELD LENGTH
CF 34-10E7 ENGINES
DRY, SMOOTH, HARD PAVED AND LEVEL RUNWAY
FLAP 5
ISA

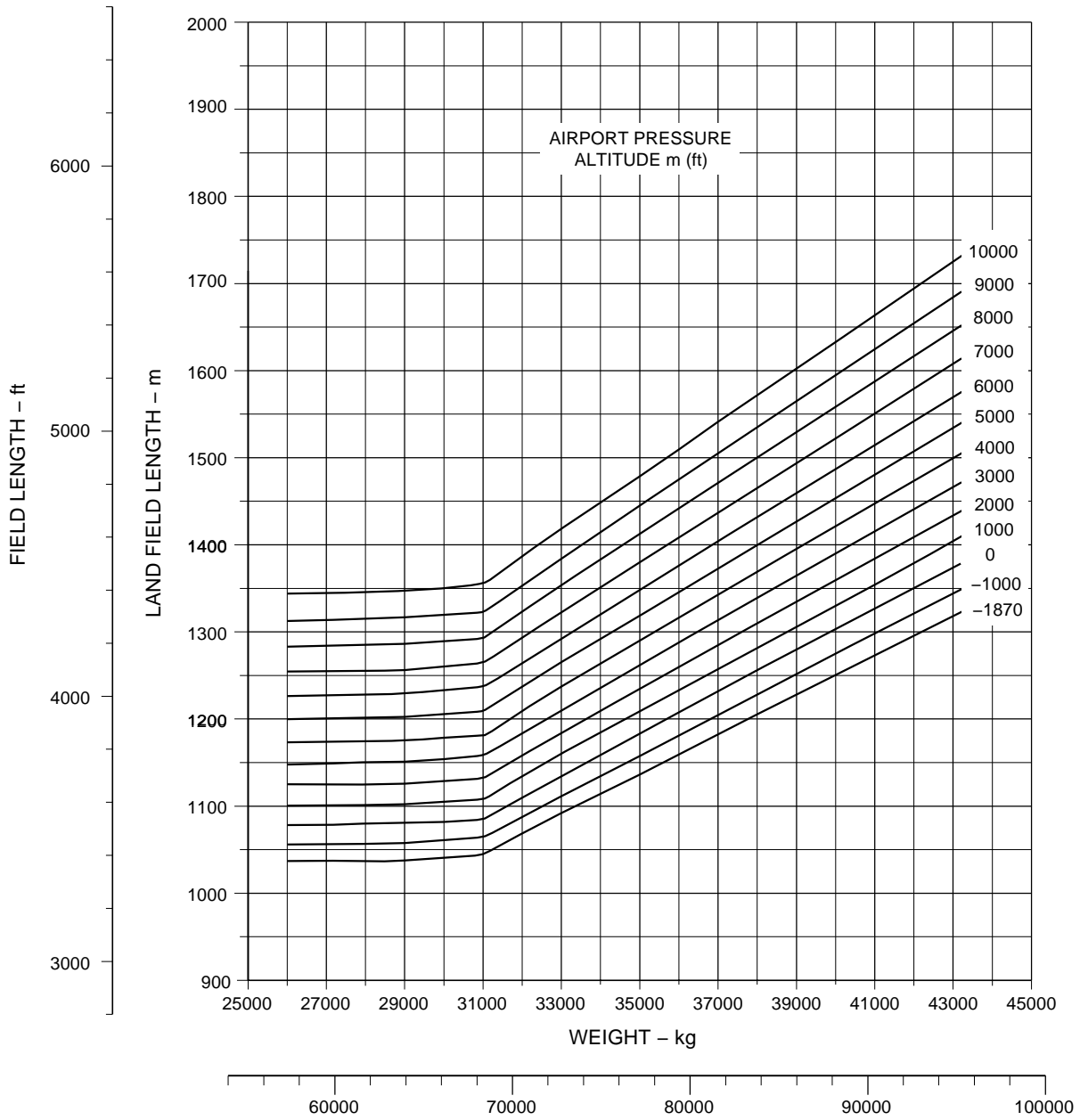
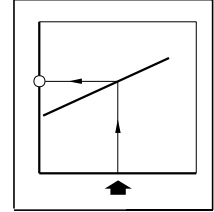

EM170APM030019A.DGN



EFFECTIVITY: FAA-CERTIFIED ACFT
Landing Field Lengths - Flaps Full
Figure 3.24

LANDING FIELD LENGTH
CF 34-10E7 ENGINES
DRY, SMOOTH, HARD PAVED AND LEVEL RUNWAY
FLAP FULL
ISA

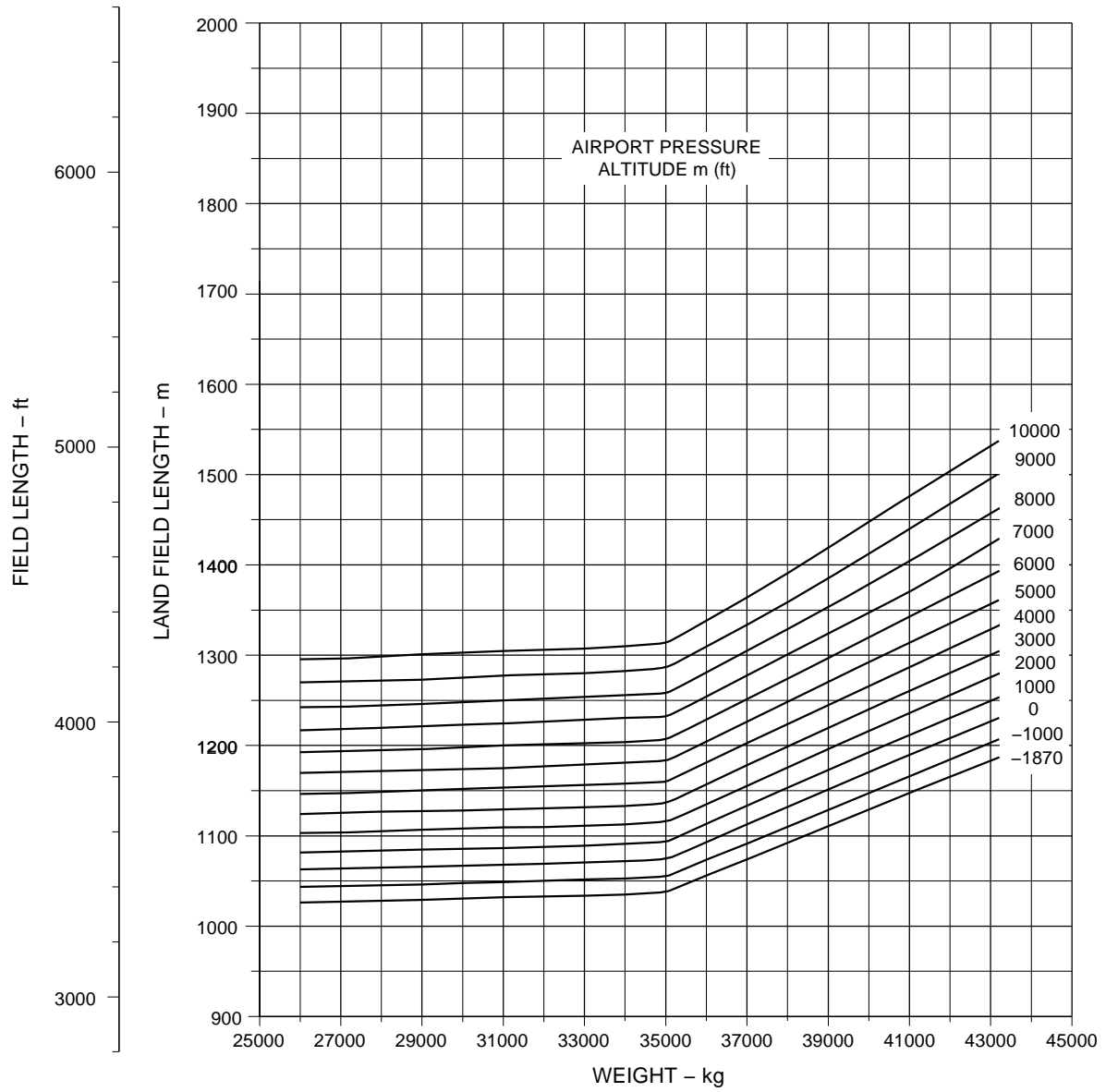
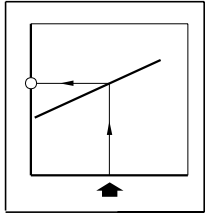

EM170APM030020A.DGN

**4. GROUND MANEUVERING***EFFECTIVITY: ALL***4.1. GENERAL INFORMATION**

This section provides the aircraft turning capability and maneuvering characteristics. To facilitate the presentation, these data have been determined from theoretical limits imposed by the geometry of the aircraft.

As such, they reflect the turning capability of the aircraft in favorable operating circumstances. These data should be used only as guidelines for the method of determining such parameters and for the maneuvering characteristics of the aircraft.

In the ground operating mode, varying airline practices may demand that more conservative turning procedures be adopted, to avoid excessive tire wear and reduce possible maintenance problems.

Variations from standard aircraft operating patterns may be necessary to satisfy physical constants within the maneuvering area, such as adverse grades, limited area, or high risk of jet blast damage. For these reasons, the ground maneuvering requirements should be coordinated with the using airline prior to the layout planning.

This section is presented as follows:

- The turning radii for nose landing gear steering angles.
- The pilot's visibility from the cockpit and the limits of ambinocular vision through the windows. Ambinocular vision is defined as the total field of vision seen by both eyes at the same time.
- The performance of the aircraft on runway-to-taxiway, taxiway-to-taxiway and runway holding bays dimensions.

4.2. TURNING RADII

This subsection presents the following information:

- The turning radii for various nose landing gear steering angles. The minimum turning radius is determined, considering that the maximum nose landing gear steering angle is 76 degrees left and right.
- Data on the minimum width of the pavement for a 180° turn.



EFFECTIVITY: ALL
Turning Radii - No Slip Angle
Figure 4.1

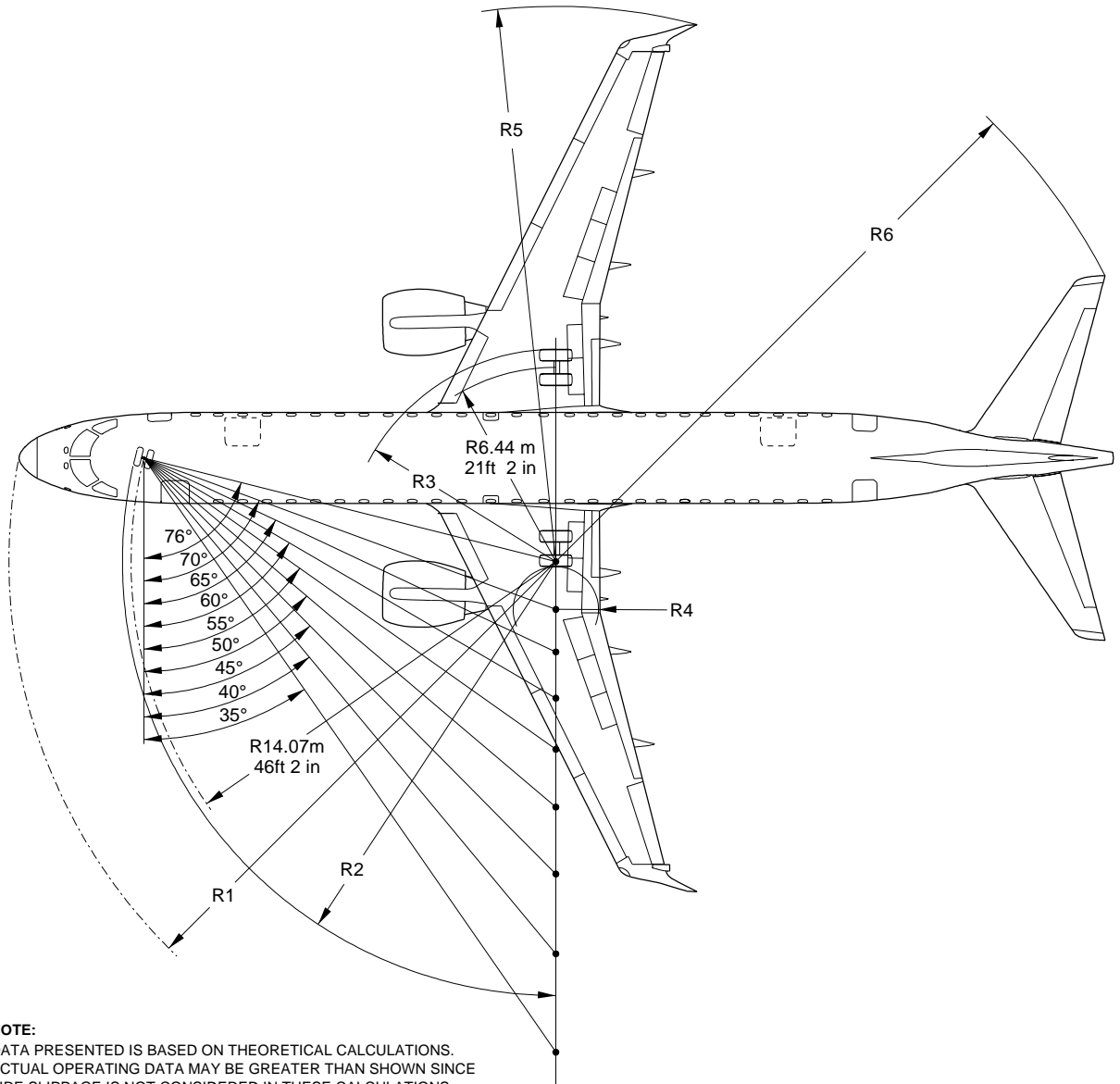

NOTE:
DATA PRESENTED IS BASED ON THEORETICAL CALCULATIONS.
ACTUAL OPERATING DATA MAY BE GREATER THAN SHOWN SINCE
TIRE SLIPPAGE IS NOT CONSIDERED IN THESE CALCULATIONS.

| STEERING STEEL | NOSE | | NOSE GEAR | | OUTBOARD GEAR | | INBOARD GEAR | | RIGHT WINGLET | | RIGHT TAILTIP | |
|-------------------|------------------------|------------------------|------------------------|-----------------------|------------------------|------------------------|--------------|--|---------------|--|---------------|--|
| | R1 | R2 | R3 | R4 | R5 | R6 | | | | | | |
| 35° | 26.53 m 87 ft | 24.16 m 79 ft 3 in | 23.28 m 76 ft 5 in | 16.08 m 52 ft 9 in | 34.35 m 112 ft 8 in | 31.50 m 103 ft 4 in | | | | | | |
| 40° | 24.21 m 79 ft 5 in | 21.58 m 70 ft 10 in | 20.03 m 65 ft 9 in | 12.82 m 42 ft 1 in | 31.13 m 102 ft 2 in | 28.91 m 94 ft 10 in | | | | | | |
| 45° | 22.50 m 73 ft 10 in | 19.64 m 64 ft 5 in | 17.38 m 57 ft | 10.18 m 35 ft 5 in | 28.52 m 93 ft 7 in | 26.90 m 88 ft 3 in | | | | | | |
| 50° | 21.22 m 69 ft 7 in | 18.14 m 59 ft 6 in | 15.17 m 49 ft 9 in | 7.96 m 26 ft 1 in | 26.33 m 86 ft 5 in | 25.32 m 83 ft 1 in | | | | | | |
| 55° | 20.24 m 66 ft 5 in | 16.98 m 55 ft 9 in | 13.25 m 43 ft 6 in | 6.05 m 19 ft 10 in | 24.45 m 80 ft 3 in | 24.02 m 78 ft 10 in | | | | | | |
| 60° | 19.49 m 63 ft 11 in | 16.07 m 52 ft 9 in | 11.56 m 37 ft 11 in | 4.35 m 14 ft 3 in | 22.79 m 74 ft 9 in | 22.95 m 75 ft 4 in | | | | | | |
| 65° | 18.91 m 63 ft | 15.36 m 50 ft 5 in | 10.03 m 32 ft 11 in | 2.82 m 9 ft 3 in | 21.30 m 69 ft 10 in | 22.05 m 72 ft 4 in | | | | | | |
| 70° | 18.48 m 60 ft 8 in | 14.82 m 48 ft 7 in | 8.62 m 28 ft 3 in | 1.41 m 4 ft 8 in | 19.93 m 65 ft 5 in | 21.29 m 69 ft 10 in | | | | | | |
| 76° | 18.12 m 59 ft 5 in | 14.36 m 47 ft 1 in | 7.04 m 23 ft 1 in | 0.17 m 7 in | 18.39 m 60 ft 4 in | 20.51 m 67 ft 3 in | | | | | | |

EM170APM040008B.DGN



4.3. **MINIMUM TURNING RADII**



EFFECTIVITY: ALL
Minimum Turning Radius
Figure 4.2

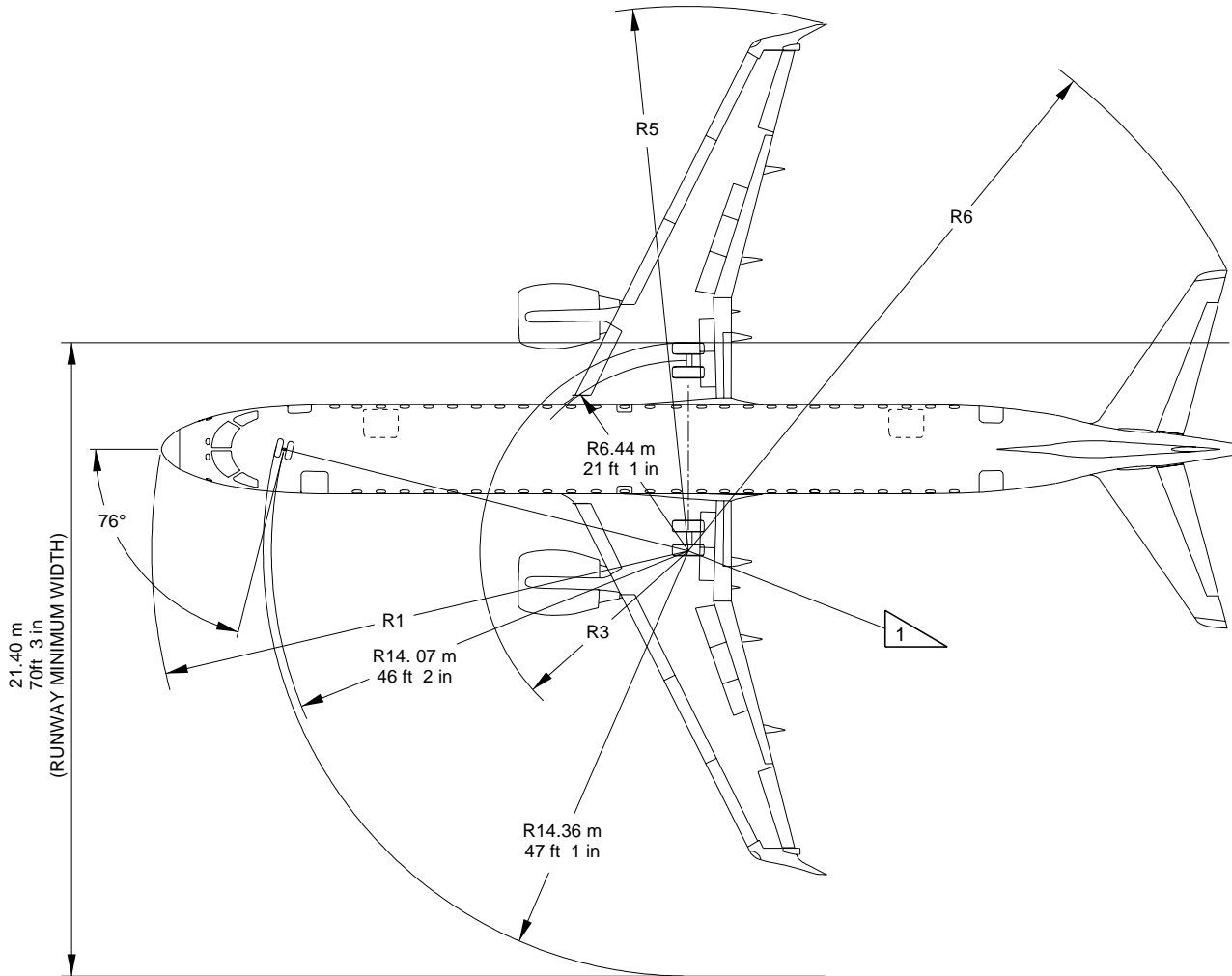

NOTE:
ACTUAL OPERATING DATA MAY BE GREATER THAN VALUES SHOWN
SINCE TIRE SLIPPAGE IS NOT CONSIDERED IN THESE CALCULATIONS.

| STEERING STEEL | NOSE | | NOSE GEAR | | OUTBOARD GEAR | | INBOARD GEAR | | RIGHT WINGLET | | RIGHT TAILTIP | |
|-------------------|---------|------------|-----------|------------|---------------|------------|--------------|------|---------------|------------|---------------|------------|
| | R1 | R2 | R2 | R2 | R3 | R3 | R4 | R4 | R5 | R5 | R6 | R6 |
| 76° | 18.12 m | 59 ft 5 in | 14.36 m | 47 ft 1 in | 7.04 m | 23 ft 1 in | 0.17 m | 7 in | 18.39 m | 60 ft 4 in | 20.51 m | 67 ft 3 in |

1 THEORETICAL CENTER OF TURN FOR MINIMUM RADIUS.
SHOWS CONTINUOUS TURNING WITH ENGINE THRUST AS REQUIRED.
NO DIFFERENTIAL BRAKING.

EM170APM040009B.DGN



4.4. **VISIBILITY FROM COCKPIT**



EFFECTIVITY: ALL

Visibility from Cockpit in Static Position

Figure 4.3

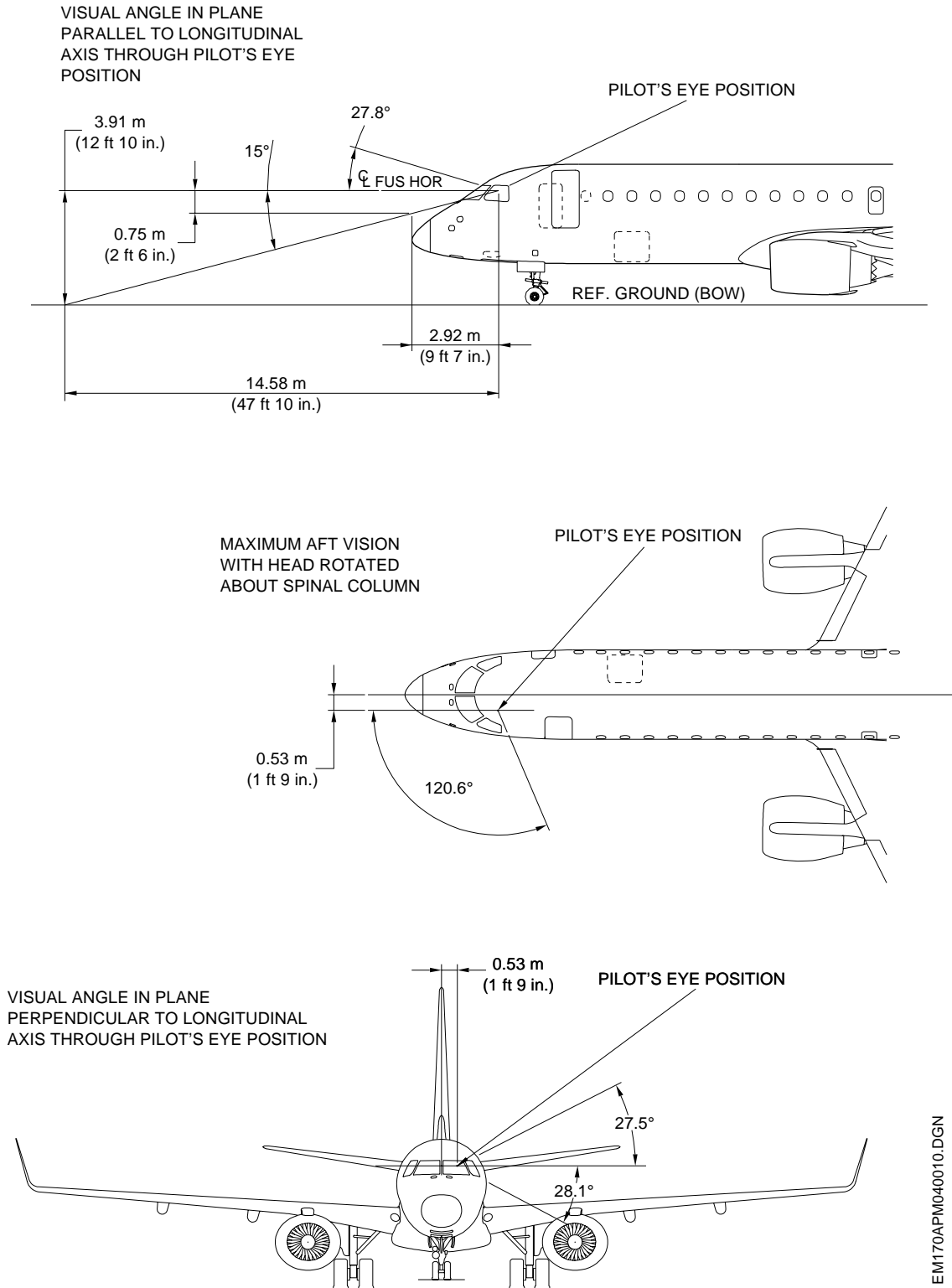

EM170APM040010.DGN

**4.5. RUNWAY AND TAXIWAY DIMENSIONS**

To determine the minimum dimensions for runway and taxiway where the aircraft can be operated, the reference code of the aircraft must be determined.

The reference code of a specific aircraft is obtained in accordance with the Aerodrome Design and Operations - Volume 1, by the ICAO.

The code is composed of two elements which are related to the aircraft performance characteristics and dimensions:

- Element 1 is a number based on the aircraft reference field length;
- Element 2 is a letter based on the aircraft wingspan and outer main landing gear wheel span.

The table below shows the reference codes:

Table 4.1 - Reference Codes

| CODE ELEMENT 1 | | CODE ELEMENT 2 | | |
|----------------|---|----------------|---|---|
| CODE NUMBER | AIRCRAFT REFERENCE FIELD LENGTH | CODE LETTER | WING SPAN | OUTER MAIN LANDING GEAR WHEEL SPAN |
| 1 | less than 800 m (2624 ft 8 in) | A | Up to 15 m (49 ft 3 in) | Up to 4.5 m (14 ft 9 in) |
| 2 | 800 m (2624 ft 8 in) up to 1200 m (3937 ft) | B | 15 m (49 ft 3 in) to 24 m (78 ft 9 in) | 4.5 m (14 ft 9 in) to 6 m (19 ft 8 in) |
| 3 | 1200 m (3937 ft) up to 1800 m (5905 ft 6 in) | C | 24 m (78 ft 9 in) to 36 m (118 ft 1 in) | 6 m (19 ft 8 in) to 9 m (29 ft 6 in) |
| 4 | 1800 m (5905 ft 6 in) and over | D | 36 m (118 ft 1 in) to 52 m (170 ft 7 in) | 9 m (29 ft 6 in) to 14 m (45 ft 11 in) |
| 5 | – | E | 52 m (170 ft 7 in) to 65 m (213 ft 3 in) | 9 m (29 ft 6 in) to 14 m (45 ft 11 in) |

In accordance with the table, the reference code is 3C for EMBRAER 190STD, EMBRAER 190LR and EMBRAER 190AR.

- NOTE:**
- This classification may change depending on aircraft engine model and takeoff weight.
 - For further information, refer to AOM.

With the reference code it is possible to obtain the limits of the runway and taxiway where the aircraft can be operated.

For reference code 3C the limits are:

- The width of a runway should be not less than 30 m (98 ft 5 in);
- The width of a taxiway should be not less than 15 m (49 ft 2 in);
- The design of the curve in a taxiway should be such that, when the cockpit remains over the taxiway centre line marking, the clearance distance between the outer main landing gear wheels of the aircraft and the edge of the taxiway should not be less than 3 m (9 ft 10 in);
- The clearance between a parked aircraft and one moving along the taxiway in a holding bay should not be less than 15 m (49 ft 2 in).



For reference code 4C the limits are:

- The width of a runway should be not less than 30 m (147 ft 7.6 in);
- The width of a taxiway should be not less than 15 m (49 ft 2 in);
- The design of the curve in a taxiway should be such that, when the cockpit remains over the taxiway centre line marking, the clearance distance between the outer main landing gear wheels of the aircraft and the edge of the taxiway should not be less than 3 m (9 ft 10 in);
- The clearance between a parked aircraft and one moving along the taxiway in a holding bay should not be less than 15 m (49 ft 2 in).



EFFECTIVITY: EMBRAER 190 STD ACFT MODEL
More than 90° Turn - Runway to Taxiway
Figure 4.4

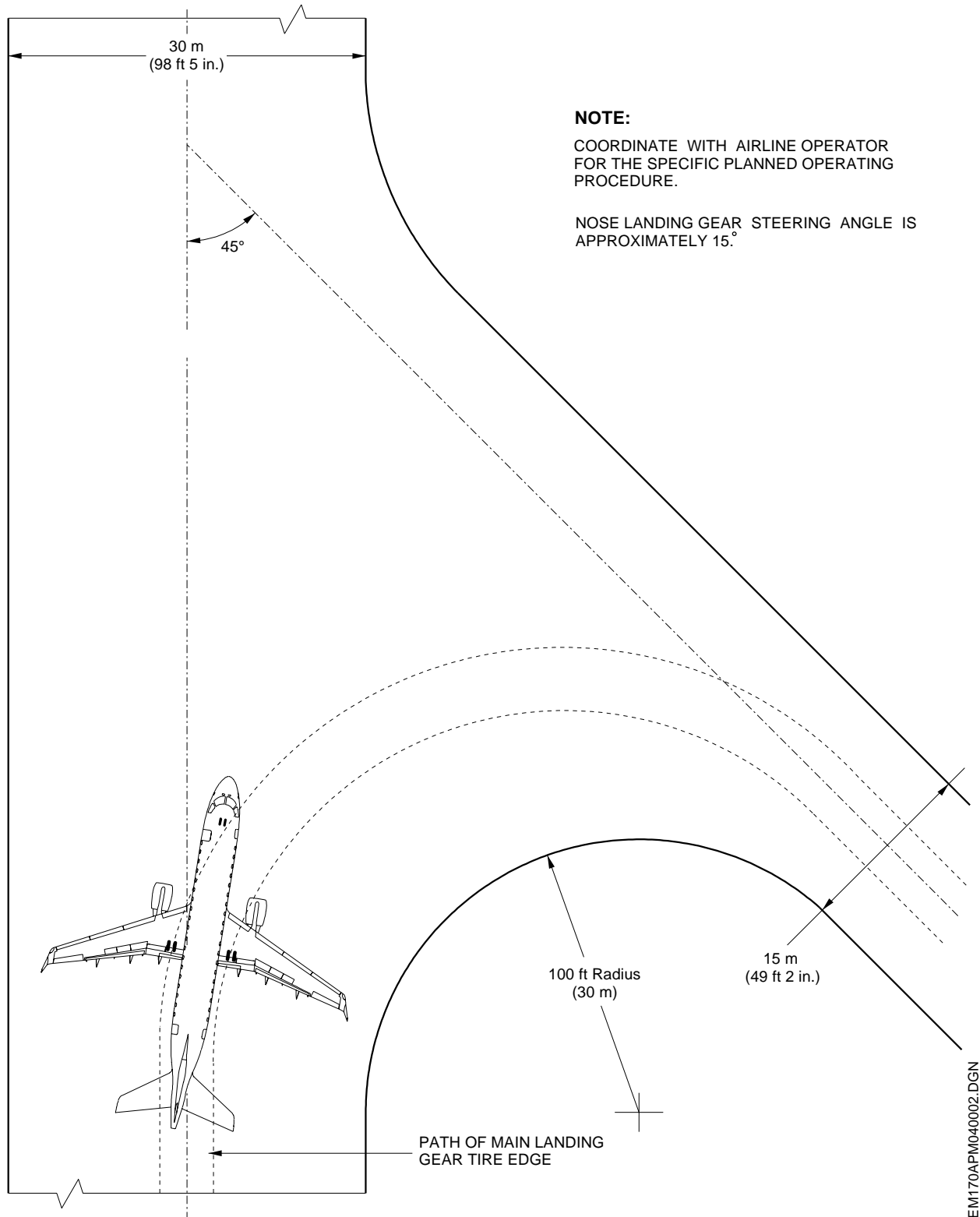



EFFECTIVITY: EMBRAER ACFT 190 LR OR AR MODEL
More than 90° Turn - Runway to Taxiway
Figure 4.5

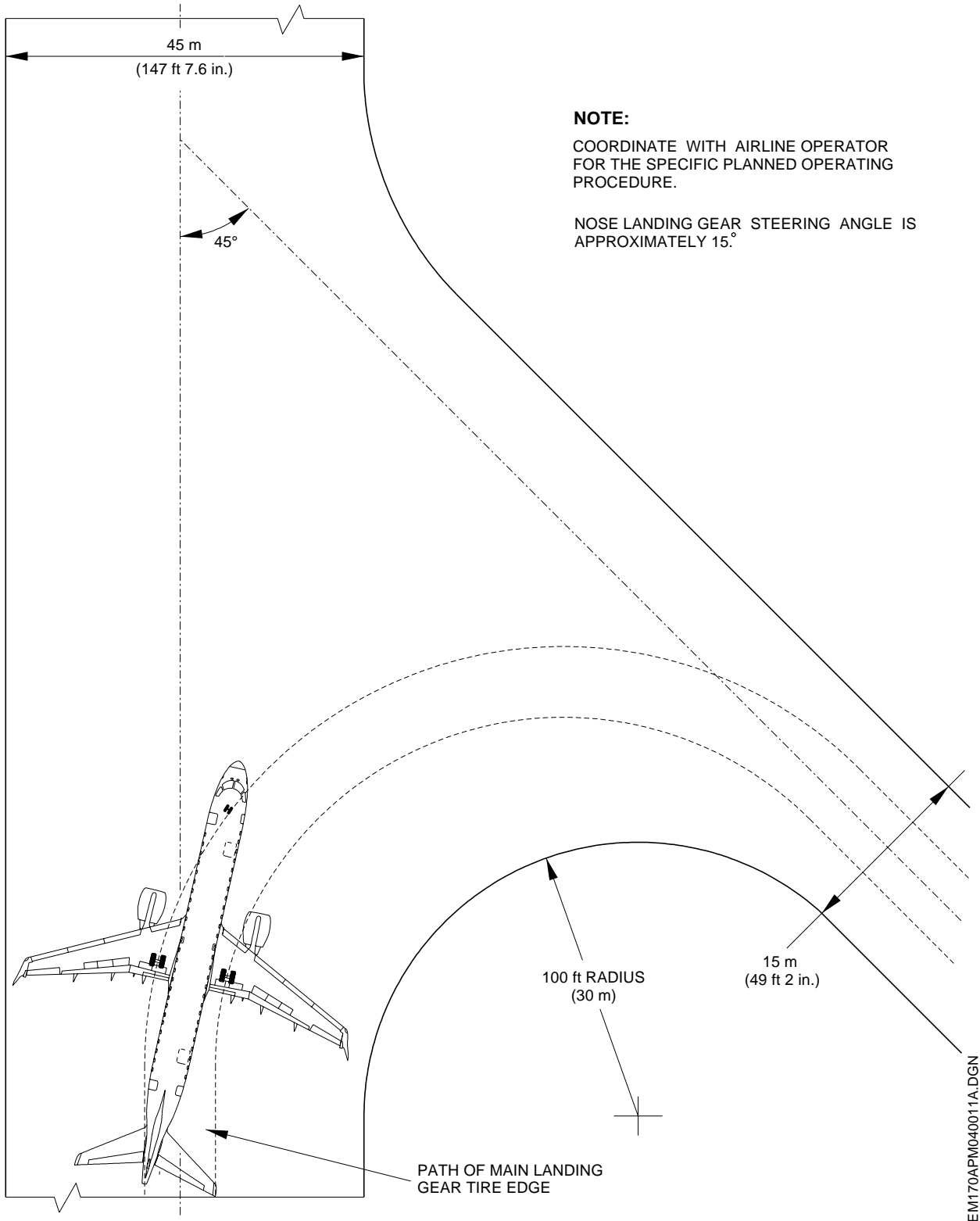



EFFECTIVITY: EMBRAER 190 STD ACFT MODEL
90° Turn - Runway to Taxiway
Figure 4.6

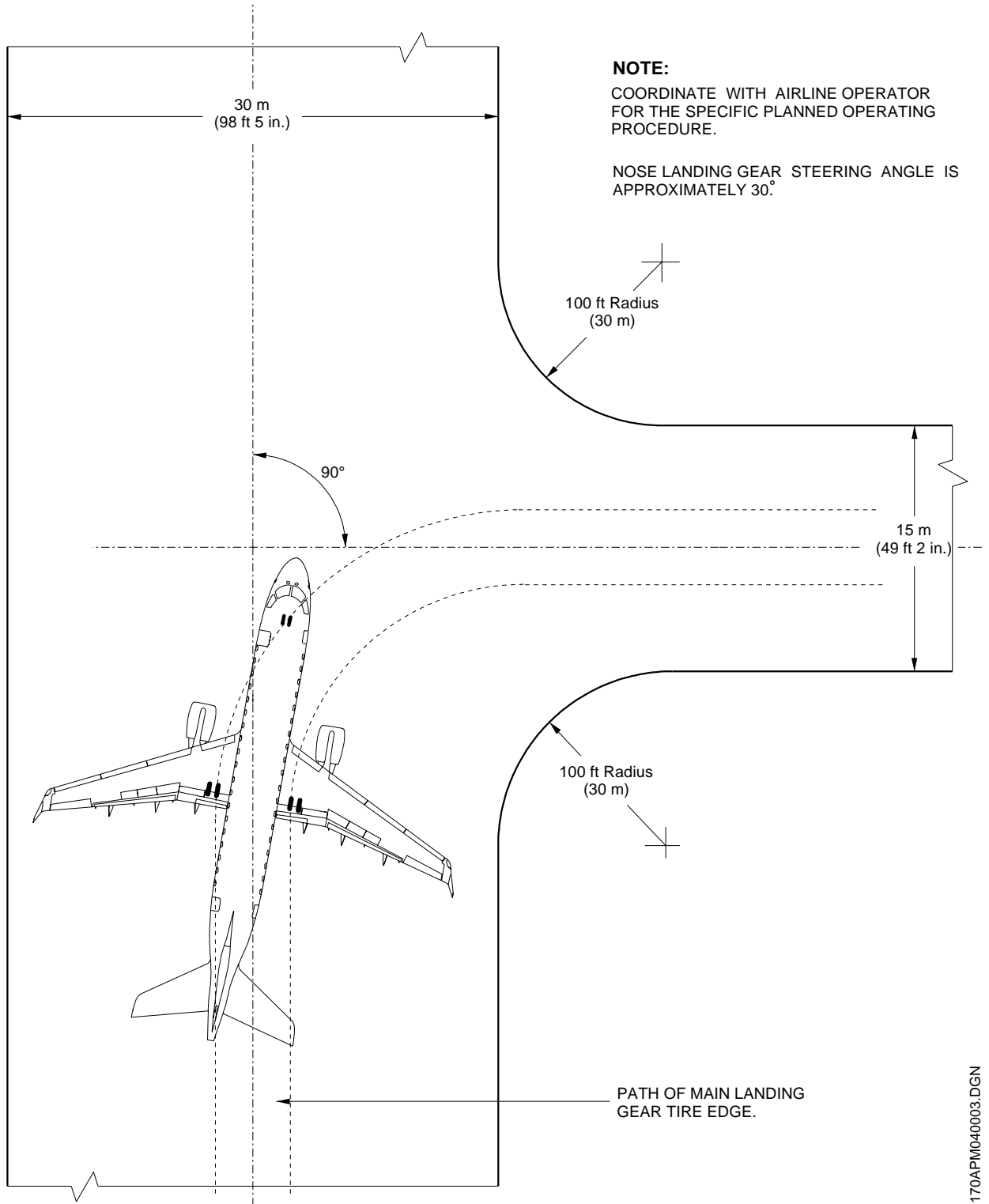

EM170APM040003.DGN



EFFECTIVITY: EMBRAER ACFT 190 LR OR AR MODEL
90° Turn - Runway to Taxiway
Figure 4.7

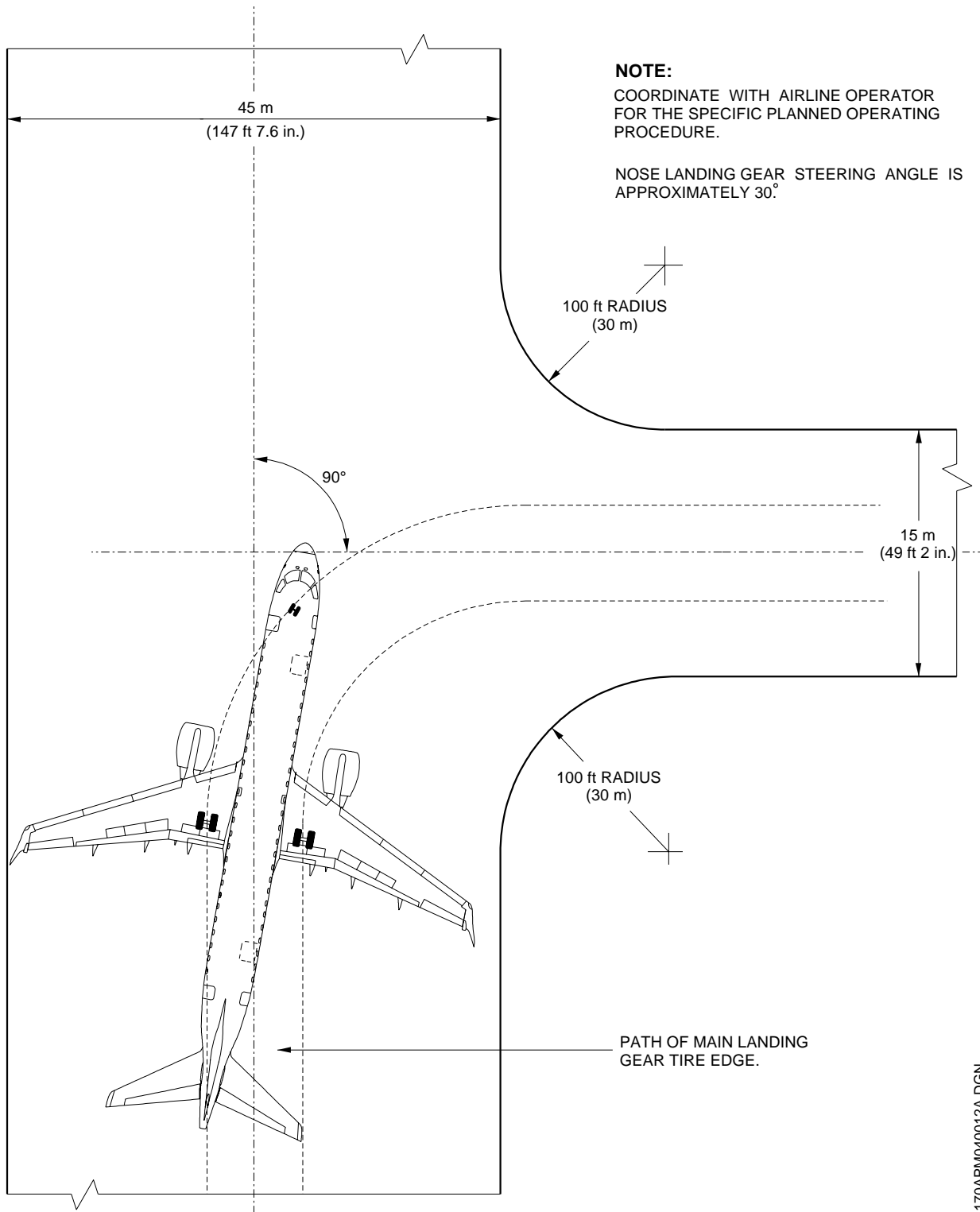

EM170APM040012A.DGN



EFFECTIVITY: ALL

90° Turn - Taxiway to Taxiway

Figure 4.8

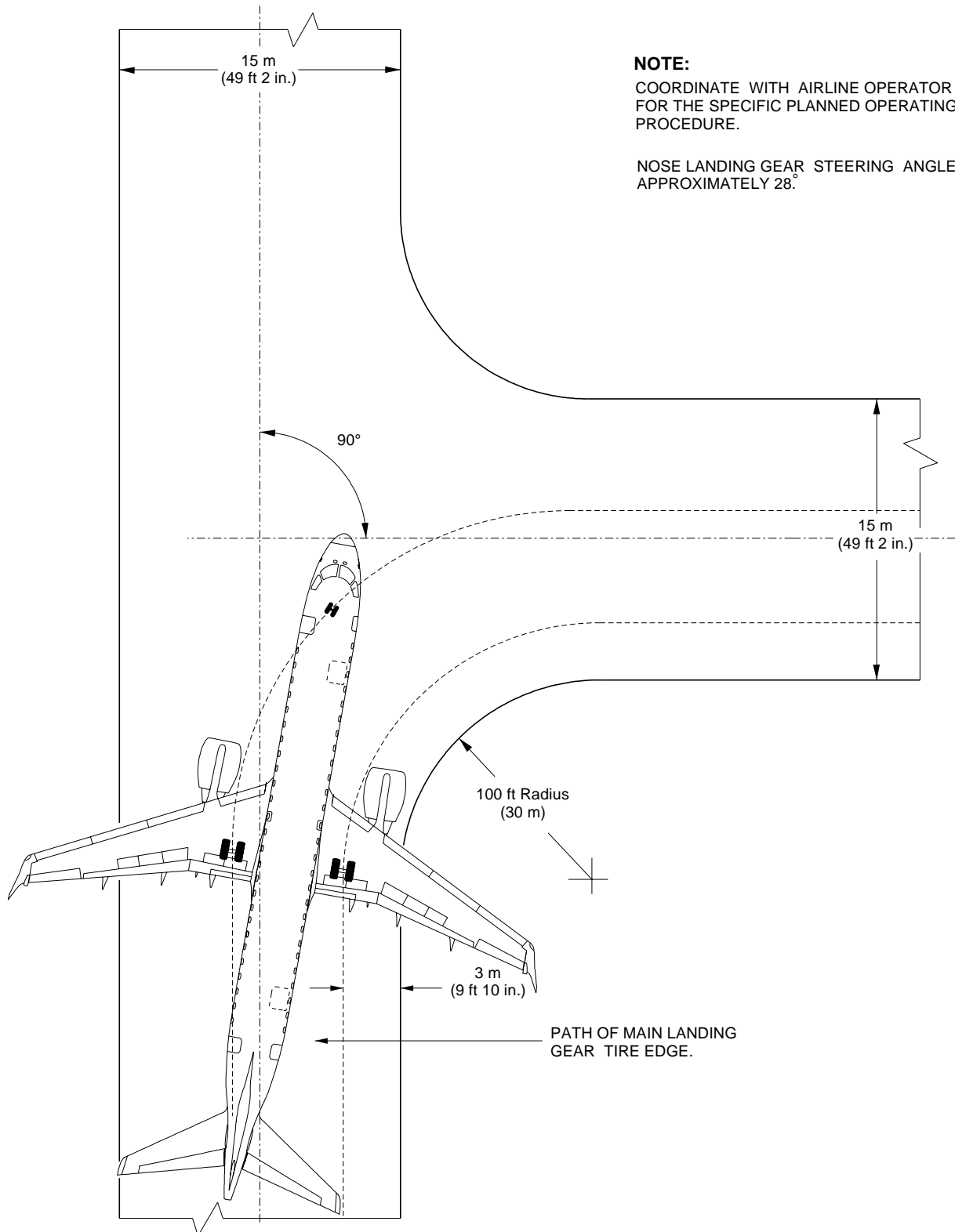

EM170APM040013.DGN



4.6. **RUNWAY HOLDING APRON**



EFFECTIVITY: EMBRAER 190 STD ACFT MODEL
Runway Holding Bay
Figure 4.9

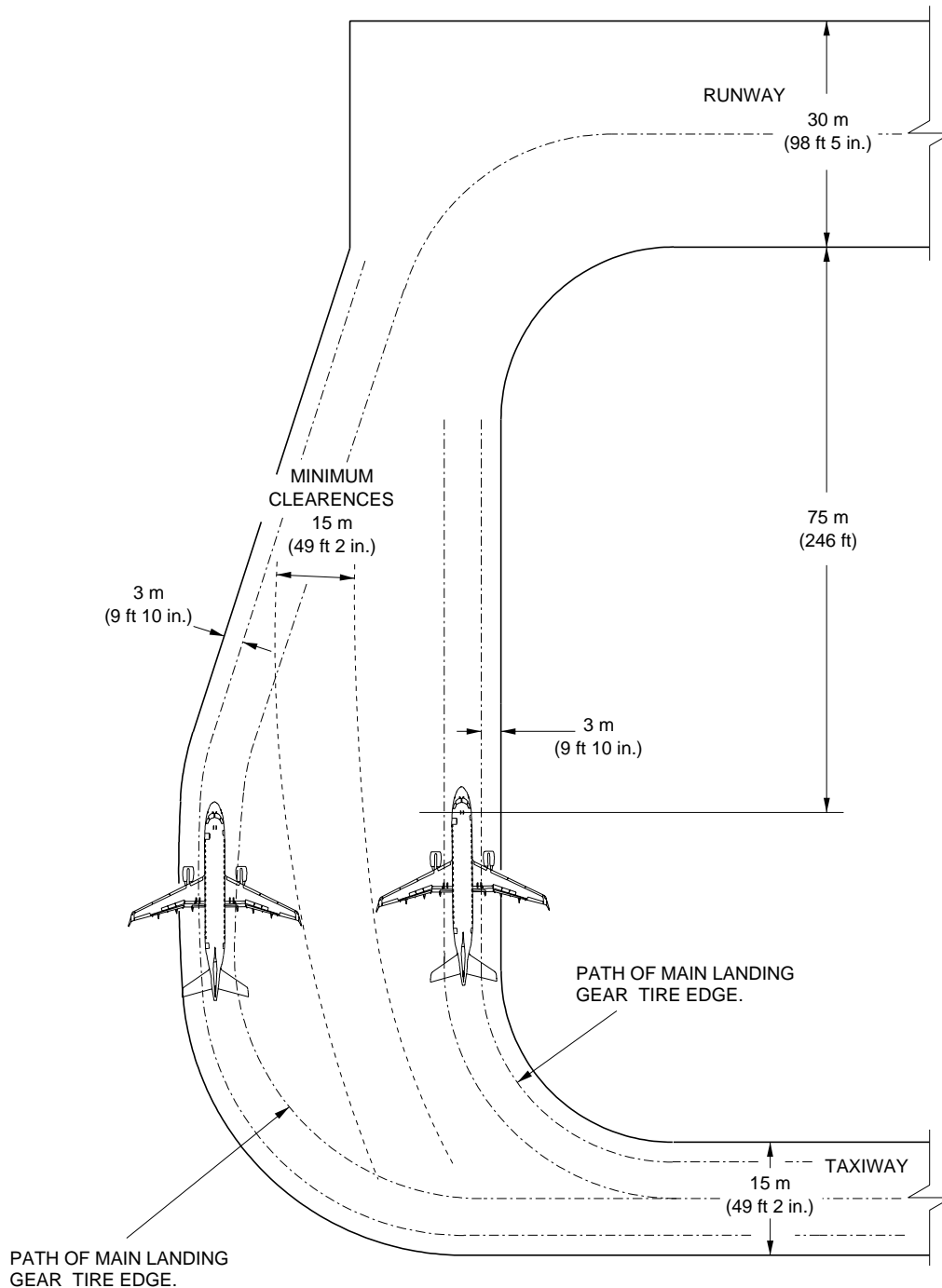

EM170APM040005.DGN



EFFECTIVITY: EMBRAER ACFT 190 LR OR AR MODEL
Runway Holding Bay
Figure 4.10

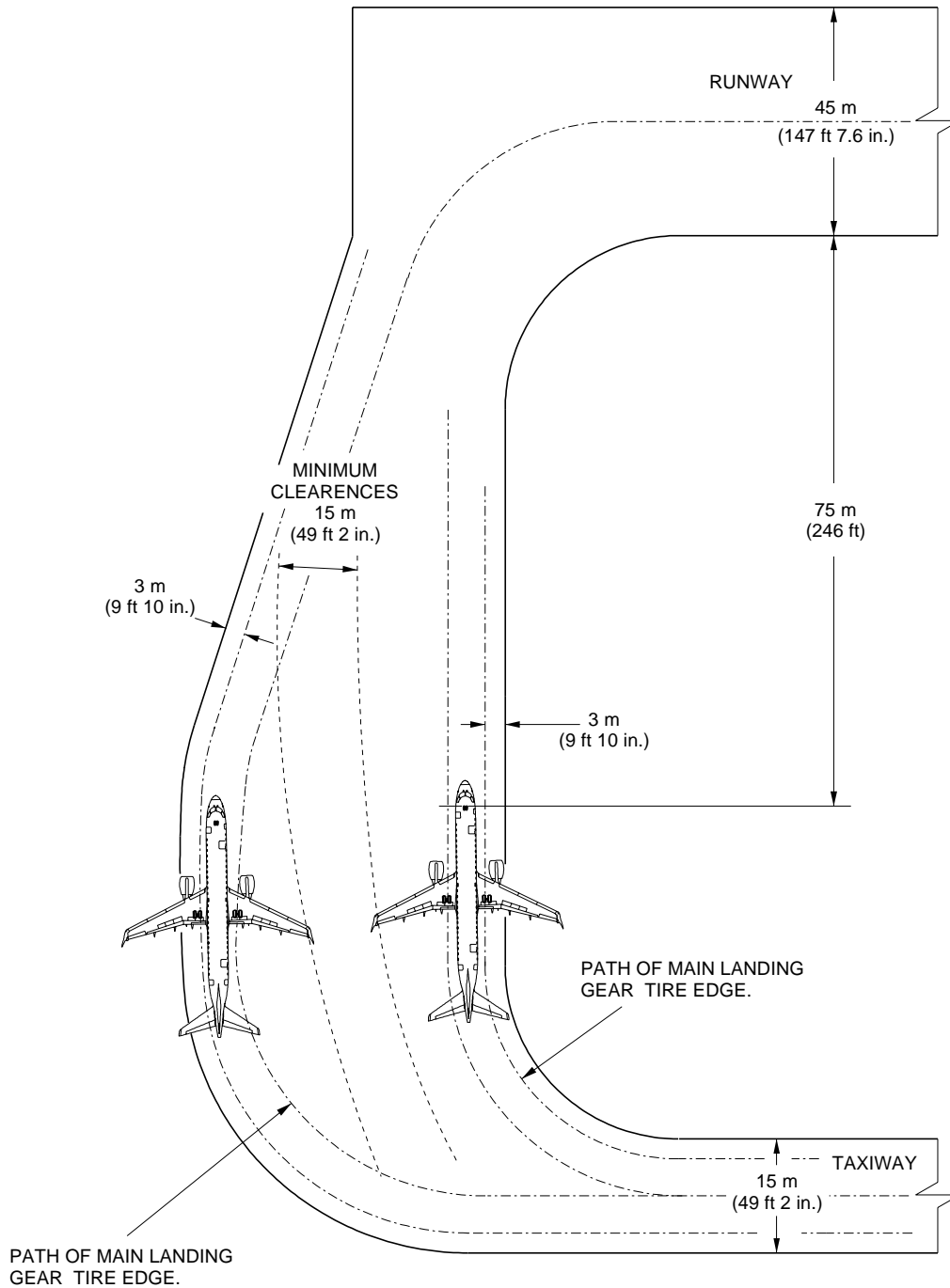

EM170APM040014A.DGN

**5. TERMINAL SERVICING***EFFECTIVITY: ALL***5.1. GENERAL**

During turnaround at the air terminal, certain services must be performed on aircraft, usually within a given time to meet flight schedules. This section shows service vehicle arrangements, schedules, locations of servicing points, and typical servicing requirements. The data presented herein reflect ideal conditions for a single aircraft. Servicing requirements may vary according to the aircraft condition and airline operational (servicing) procedures.

This section provides the following information:

- The typical arrangements of equipments during turnaround;
- The typical turnaround servicing time at an air terminal;
- The locations of ground servicing connections in graphic and tabular forms;
- The typical sea level air pressure and flow requirements for starting the engine;
- The air conditioning requirements;
- The ground towing requirements for various towing conditions. Towbar pull and total traction wheel load may be determined by considering aircraft weight, pavement slope, coefficient of friction, and engine idle thrust.

5.2. AIRCRAFT SERVICING ARRANGEMENT



EFFECTIVITY: ALL

Aircraft Servicing Arrangement With Passenger Stairs

Figure 5.1

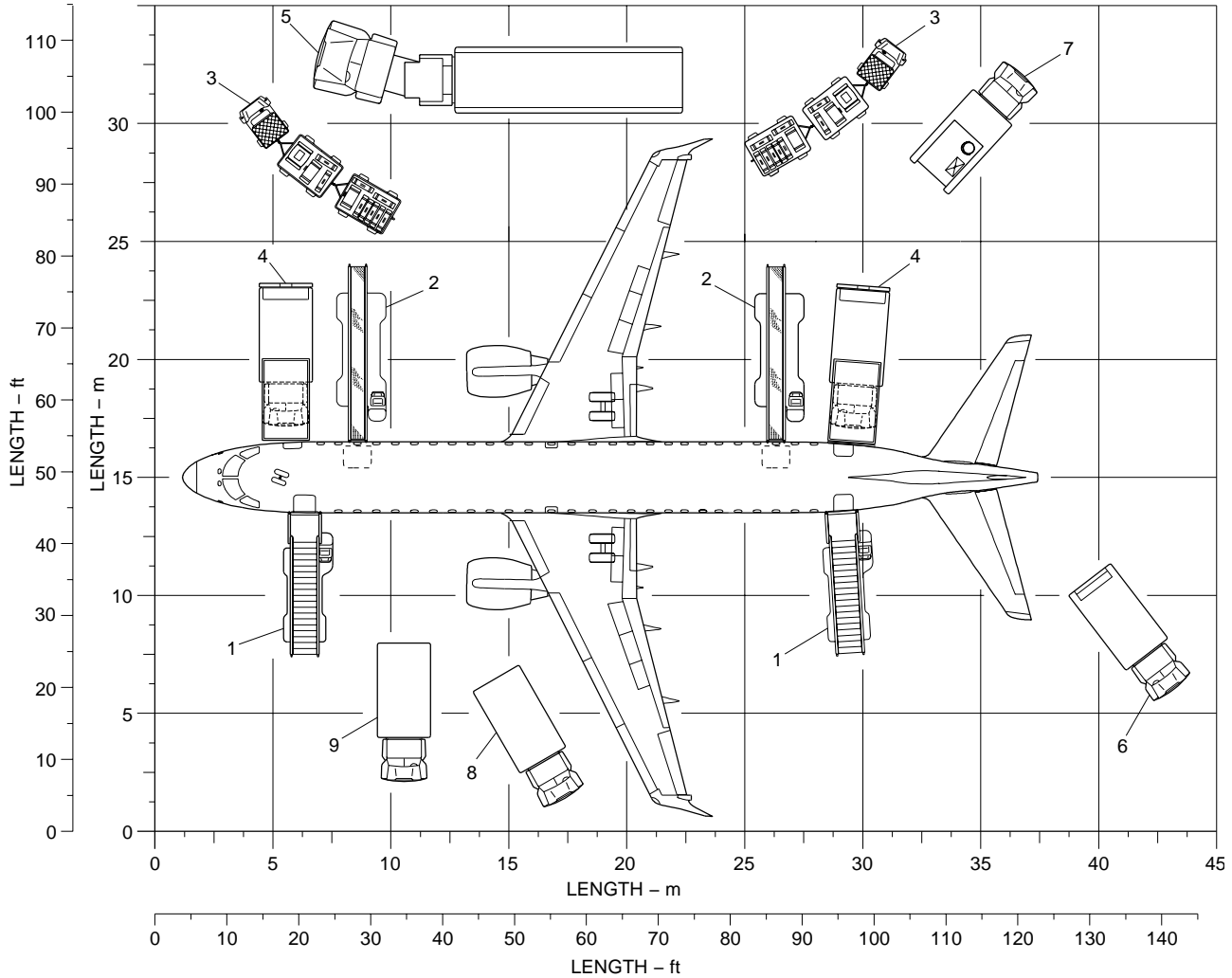

SERVICING ARRANGEMENT

- 01 – PASSENGER STAIRS
- 02 – BAGGAGE LOADER
- 03 – BAGGAGE / CARGO
- 04 – GALLEY SERVICE
- 05 – FUEL SERVICE
- 06 – POTABLE WATER
- 07 – LAVATORY SERVICE
- 08 – AIR CONDITIONING
- 09 – PNEUMATIC STARTER

EM170APM050011A.DGN



EFFECTIVITY: ALL

Aircraft Servicing Arrangement With Passenger Bridge

Figure 5.2

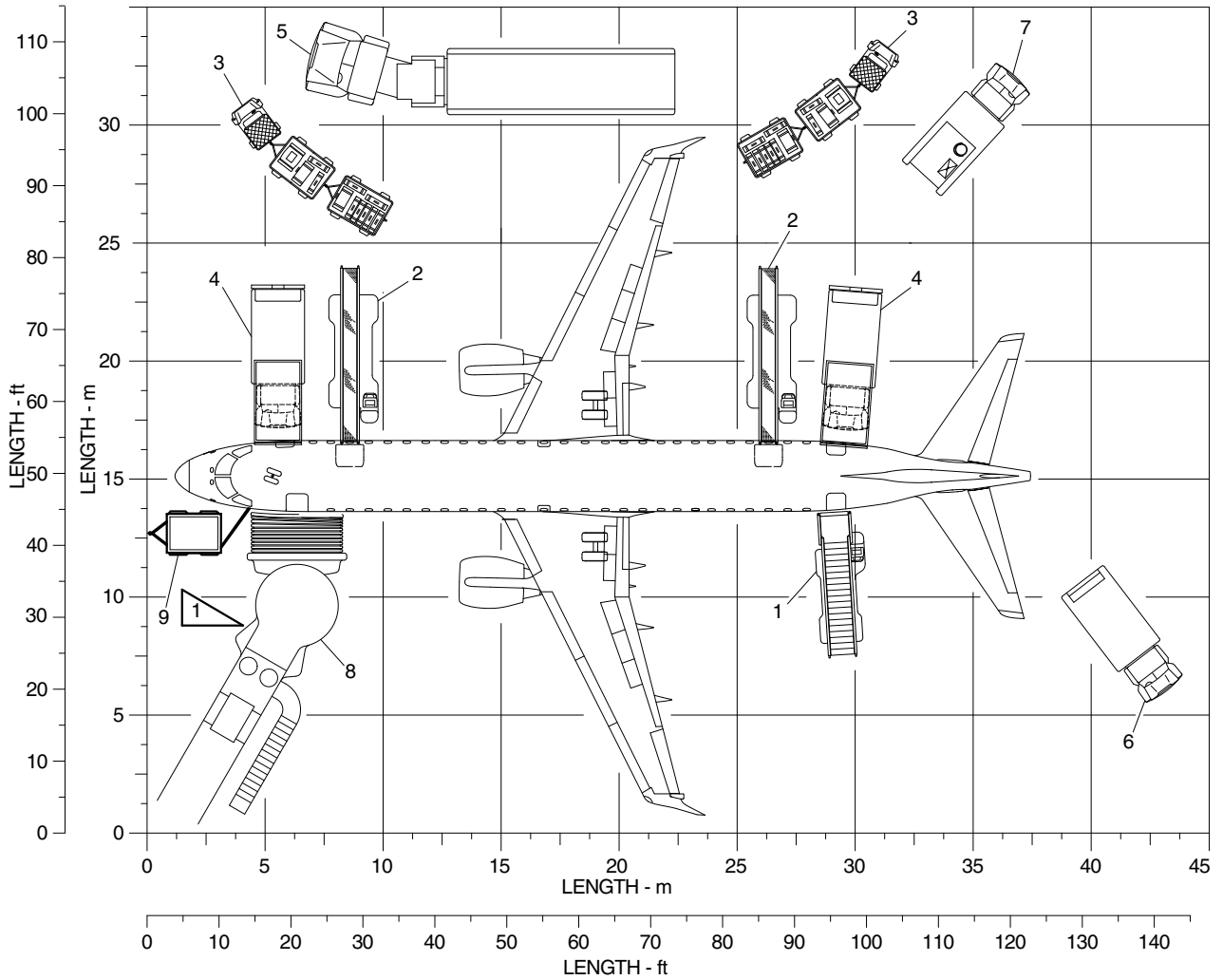

SERVICING ARRANGEMENT

- 01 - PASSENGER STAIRS
- 02 - BAGGAGE LOADER
- 03 - BAGGAGE / CARGO
- 04 - GALLEY SERVICE
- 05 - FUEL SERVICE
- 06 - POTABLE WATER
- 07 - LAVATORY SERVICE
- 08 - PASSENGER BRIDGE
- 09 - GROUND POWER UNIT



THE GPU CAN BE MOVED TO BETTER POSITION CONSIDERING THE GROUND CONNECTION AND THE CABLE EXTENSION.

EM170APM050012A.IDR



5.3. TERMINAL OPERATIONS - TURNAROUND STATION

This section presents the typical turnaround servicing time at an air terminal. The chart gives typical schedules for performing servicing on the aircraft within a given time.

The time of each service in the chart was calculated taking the following into consideration:

- Load factor - 100%;
- Passenger deplane - 24 pax/min;
- Passenger enplane - 16 pax/min;
- Baggages checked per passenger - 1,2;
- Refuel (fuel quantity) - 80%;
- Flow - 290 gpm;
- Potable water - 70% to be refilled (56 ℓ);
- Galley service FWD and aft sequence - in parallel;
- Toilet type - vacuum;
- Baggages unloading/loading FWD/aft sequence - in parallel;
- Only FWD passenger door to be used to deplane and enplane passengers.

Servicing times could be rearranged to suit availability of personnel, aircraft configuration, and degree of servicing required.

The data illustrates the general scope and tasks involving airport terminal operations. Airline particular practices and operating experience will result in different sequences and intervals.



EFFECTIVITY: ALL
Air Terminal Operation - Turnaround Station
Figure 5.3

| ELAPSED TIME (MINUTES) | | ↓ | 1 | 2 | 3 | 4 | 5 | 6 | 7 | 8 | 9 | 10 | 11 | 12 | 13 | 14 | 15 | 16 | 17 | 18 | 19 | 20 |
|----------------------------|----------------------------------|------|---|---|---|---|---|---|---|---|---|----|----|----|----|----|----|----|----|----|----|----|
| OPERATIONS | | min. | | | | | | | | | | | | | | | | | | | | |
| PAX SERVICES | BRIDGE / STAIRS POSITIONING | 1,0 | █ | | | | | | | | | | | | | | | | | | | |
| | PASSENGERS DEPLANE | 4.1 | | | | | | | | | | | | | | | | | | | | |
| | GALLEY SERVICING-FWD | 7,0 | █ | | | | | | | | | | | | | | | | | | | |
| | GALLEY SERVICING-AFT | 7,0 | █ | | | | | | | | | | | | | | | | | | | |
| | AIRPLANE INTERIOR SERVICES | 6.1 | | | | | | | | | | | | | | | | | | | | |
| | PASSENGERS ENPLANE | 6.1 | | | | | | | | | | | | | | | | | | | | |
| | BRIDGE / STAIRS REMOVAL | 1,0 | | | | | | | | | | | | | | | | | | | | |
| | PUSH BACK / ENGINES START | 2,0 | | | | | | | | | | | | | | | | | | | | |
| BAGGAGE & CARGO | FWD BAGGAGE / CARGO UNLOAD | 4.3 | █ | | | | | | | | | | | | | | | | | | | |
| | REAR BAGGAGE / CARGO UNLOAD | 3.5 | █ | | | | | | | | | | | | | | | | | | | |
| | TIME BETWEEN UNLOADING / LOADING | 0,5 | | | | | | | | | | | | | | | | | | | | |
| | FWD BAGGAGE/CARGO LOAD | 7.1 | | | | | | | | | | | | | | | | | | | | |
| | AFT BAGGAGE/CARGO LOAD | 5.8 | | | | | | | | | | | | | | | | | | | | |
| AIRCRAFT SERVICING | FUEL SERVICE | 11.7 | █ | | | | | | | | | | | | | | | | | | | |
| | POTABLE WATER SERVICE | 3,0 | █ | | | | | | | | | | | | | | | | | | | |
| | TOILET SERVICE | 5,0 | █ | | | | | | | | | | | | | | | | | | | |

LEGEND:

█ TRUCK POSITIONING/REMOVAL/SETTINGS

NOTE:

THIS DATA ILLUSTRATES THE GENERAL SCOPE AND TASKS INVOLVING AIRPORT TERMINAL OPERATIONS. AIRLINE PARTICULAR PRACTICES AND OPERATING EXPERIENCE WILL RESULT IN DIFFERENT SEQUENCES AND INTERVALS.

EM170APM050013A.DGN



5.4. **TERMINAL OPERATIONS - EN ROUTE STATION**

Not Applicable

5.5. **GROUND SERVICING CONNECTIONS**



EFFECTIVITY: ALL
Ground Servicing Connections
Figure 5.4

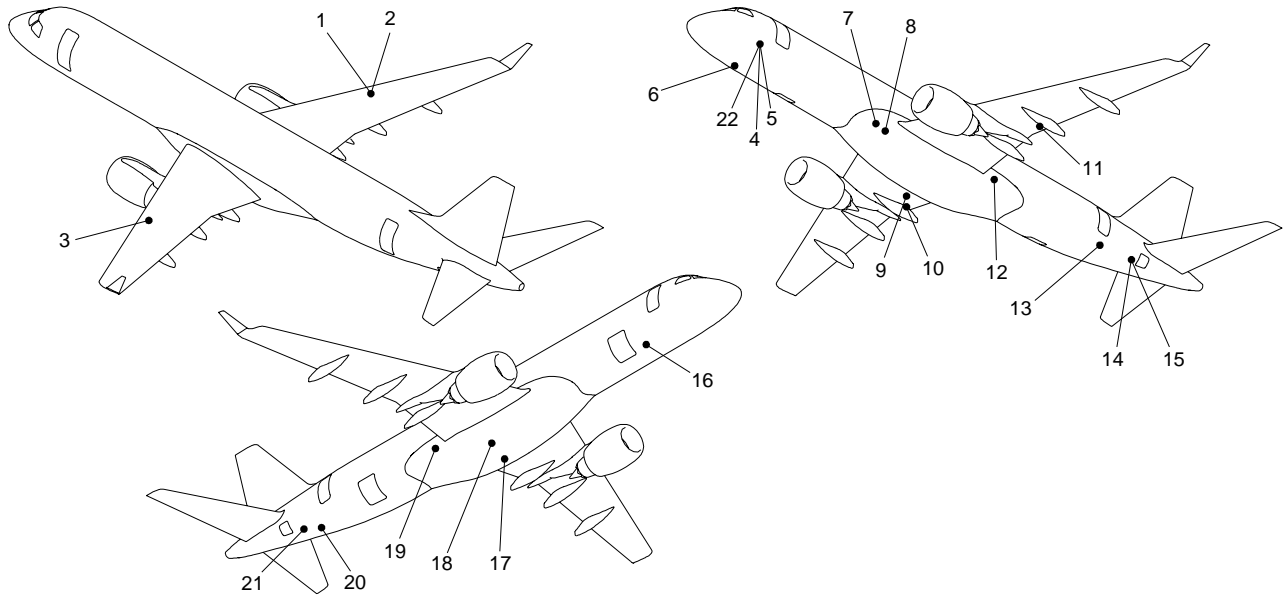

| ITEM | DESCRIPTION | COORD. X (mm) | COORD. Y (mm) | COORD. Z (mm) | HEIGHT ABOVE GROUND (mm) |
|------|---|---------------|---------------|---------------|--------------------------|
| 1 | PRESSURE REFUELING PANEL | 17316.95 | 7803.78 | -543.75 | 2862.76 |
| 2 | GRAVITY REFUELING PORT (RH) | 17695.04 | 7774.46 | -310.92 | 3104.19 |
| 3 | GRAVITY REFUELING PORT (LH) | 17932.67 | -7646.75 | -308.24 | 3112.32 |
| 4 | FORWARD RAMP HEADSET | 4164.44 | -936.13 | -1262.71 | 1842.51 |
| 5 | STEERING SWITCH DISENGAGE | 4136.97 | -951.46 | -1279.29 | 1825.31 |
| 6 | WHEEL JACK POINT - NLG | 4125.32 | 0.00 | -2854.38 | 250.36 |
| 7 | AIR COND. GROUND CONNECTION | 13268.52 | 0.00 | -1979.71 | 1334.39 |
| 8 | ENGINE AIR STARTING (LOW PRESSURE UNIT) | 13629.01 | 57.25 | -1952.83 | 1369.51 |
| 9 | GROUNDING POINT (ELECTRICAL) | 18052.28 | 2930.25 | -1744.67 | 1679.01 |
| 10 | WHEEL JACK POINT- MLG (RH) | 18078.03 | 2970.00 | -2988.86 | 435.73 |
| 11 | WHEEL JACK POINT- MLG (LH) | 18078.03 | -2970.00 | -2988.86 | 435.73 |
| 12 | HYD. SYS # 1 SERVICE PANEL | 20139.16 | -808.01 | -1602.04 | 1869.43 |
| 13 | WATER SERVICING PANEL | 27861.83 | -329.37 | -1178.74 | 2469.64 |
| 14 | EXTERNAL POWER SUPPLY 28 VDC / 400A | 30421.65 | -471.73 | -605.30 | 3101.60 |
| 15 | AFT RAMP HEADSET | 30562.26 | -449.47 | -585.54 | 3124.58 |
| 16 | OXYGEN SERVICING PANEL / BOTTLE | 6562.14 | 1159.87 | -961.05 | 2109.06 |
| 17 | FUEL TANK DRAIN VALVE (LH) | 16444.90 | -691.60 | -1611.45 | 1775.35 |
| 18 | FUEL TANK DRAIN VALVE (RH) | 16476.65 | 526.50 | -1611.45 | 1776.08 |
| 19 | HYD. SYS # 2 SERVICE PANEL | 20139.16 | 808.01 | -1602.04 | 1869.43 |
| 20 | WASTE SERVICING PANEL | 28784.01 | 349.20 | -991.80 | 2677.66 |
| 21 | HYD. SYS # 3 SERVICE PANEL | 30398.86 | 519.15 | -590.09 | 3116.29 |
| 22 | EXTERNAL POWER SUPPLY 115 VAC | 4146.90 | -810.70 | -1339.53 | 1765.31 |

NOTE:

THE GROUND CLEARANCES IN THE TABLE REFER TO THE AIRCRAFT WITH THE MINIMUM OPERATING WEIGHT (MOW) = 29500 kg (CG FWD 4.0% CMA)

EM170APM050014E.DGN



EFFECTIVITY: ALL
Ground Servicing Connections
Figure 5.5

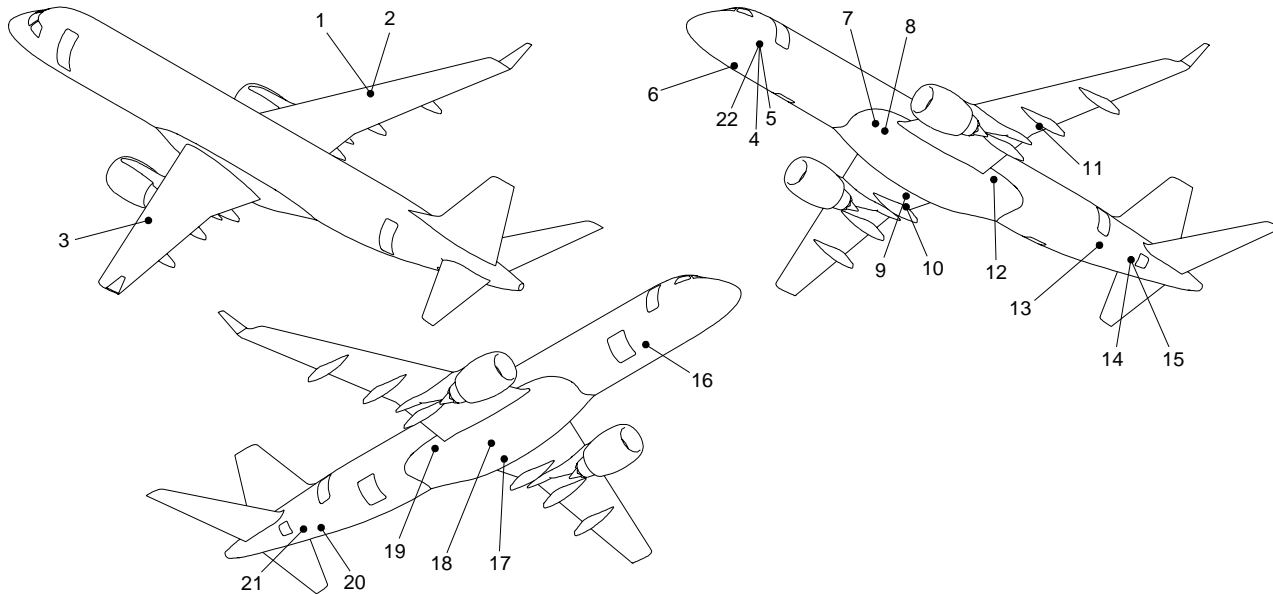

| ITEM | DESCRIPTION | COORD. X (mm) | COORD. Y (mm) | COORD. Z (mm) | HEIGHT ABOVE GROUND (mm) |
|------|---|---------------|---------------|---------------|--------------------------|
| 1 | PRESSURE REFUELING PANEL | 17316.95 | 7803.78 | -543.75 | 2849.66 |
| 2 | GRAVITY REFUELING PORT (RH) | 17695.04 | 7774.46 | -310.92 | 3088.37 |
| 3 | GRAVITY REFUELING PORT (LH) | 17932.67 | -7646.75 | -308.24 | 3094.78 |
| 4 | FORWARD RAMP HEADSET | 4146.44 | -936.13 | -1262.71 | 1924.92 |
| 5 | STEERING SWITCH DISENGAGE | 4136.97 | -951.46 | -1279.29 | 1907.92 |
| 6 | WHEEL JACK POINT - NLG | 4125.32 | 0.00 | -2854.38 | 250.48 |
| 7 | AIR COND. GROUND CONNECTION | 13268.52 | 0.00 | -1979.71 | 1350.51 |
| 8 | ENGINE AIR STARTING (LOW PRESSURE UNIT) | 13629.01 | 57.25 | -1952.83 | 1383.02 |
| 9 | GROUNDING POINT (ELECTRICAL) | 18052.28 | 2930.25 | -1744.67 | 1660.39 |
| 10 | WHEEL JACK POINT- MLG (RH) | 18077.02 | 2970.00 | -2969.64 | 428.34 |
| 11 | WHEEL JACK POINT- MLG (LH) | 18077.02 | -2970.00 | -2969.64 | 428.34 |
| 12 | HYD. SYS # 1 SERVICE PANEL | 20139.16 | -808.01 | -1602.04 | 1835.66 |
| 13 | WATER SERVICING PANEL | 27861.83 | -329.37 | -1178.74 | 2379.79 |
| 14 | EXTERNAL POWER SUPPLY 28 VDC / 400A | 30421.65 | -471.73 | -605.30 | 2993.22 |
| 15 | AFT RAMP HEADSET | 30562.26 | -449.47 | -585.54 | 3015.18 |
| 16 | OXYGEN SERVICING PANEL / BOTTLE | 6562.14 | 1159.87 | -961.05 | 2264.08 |
| 17 | FUEL TANK DRAIN VALVE (LH) | 16444.90 | -691.60 | -1611.45 | 1768.43 |
| 18 | FUEL TANK DRAIN VALVE (RH) | 16476.65 | 526.50 | -1611.45 | 1768.43 |
| 19 | HYD. SYS # 2 SERVICE PANEL | 20139.16 | 808.01 | -1602.04 | 1835.66 |
| 20 | WASTE SERVICING PANEL | 28784.01 | 349.20 | -991.80 | 2581.13 |
| 21 | HYD. SYS # 3 SERVICE PANEL | 30398.86 | 519.15 | -590.09 | 3008.07 |
| 22 | EXTERNAL POWER SUPPLY 115 VAC | 4146.90 | -810.70 | -1339.53 | 1847.84 |

NOTE:
THE GROUND CLEARANCES IN THE TABLE REFER TO THE AIRCRAFT WITH THE MINIMUM OPERATING WEIGHT (MOW) = 29500 kg (CG REAR 29.0% CMA)

EM170APM050024.DGN



5.6. **ENGINE STARTING PNEUMATIC REQUIREMENTS**



EFFECTIVITY: ALL

Engine Starting Pneumatic Requirements

Figure 5.6

TABLE 1 – PNEUMATIC ENGINE START REQUIREMENTS

| Altitude ft | Ambient Temp °C | (°F) | Minimum Pressure psia | Minimum Flow lb/min |
|-------------|--------------------|-------|--------------------------|------------------------|
| SL | -40 | (-40) | 48.0 | 95.1 |
| SL | 15 | (59) | 43.7 | 82.0 |
| SL | 49 | (120) | 40.7 | 73.7 |
| 9000 | -40 | (-40) | 37.7 | 74.5 |
| 9000 | - 5 | (23) | 30.0 | 57.3 |
| 9000 | 13 | (86) | 28.9 | 53.4 |
| 13,000 | -40 | (-40) | 36.0 | 71.3 |
| 13,000 | -11 | (12) | 27.2 | 52.2 |
| 13,000 | 21.7 | (71) | 26.7 | 49.6 |
| 15,000 | -40 | (-40) | 32.9 | 66.6 |
| 15,000 | -15 | (5) | 25.3 | 49.0 |
| 15,000 | 15 | (59) | 24.4 | 46.1 |

EM170APM050030B.DGN



5.7. **GROUND PNEUMATIC POWER REQUIREMENTS**



EFFECTIVITY: ALL

Ground Pneumatic Power Requirements

Figure 5.7

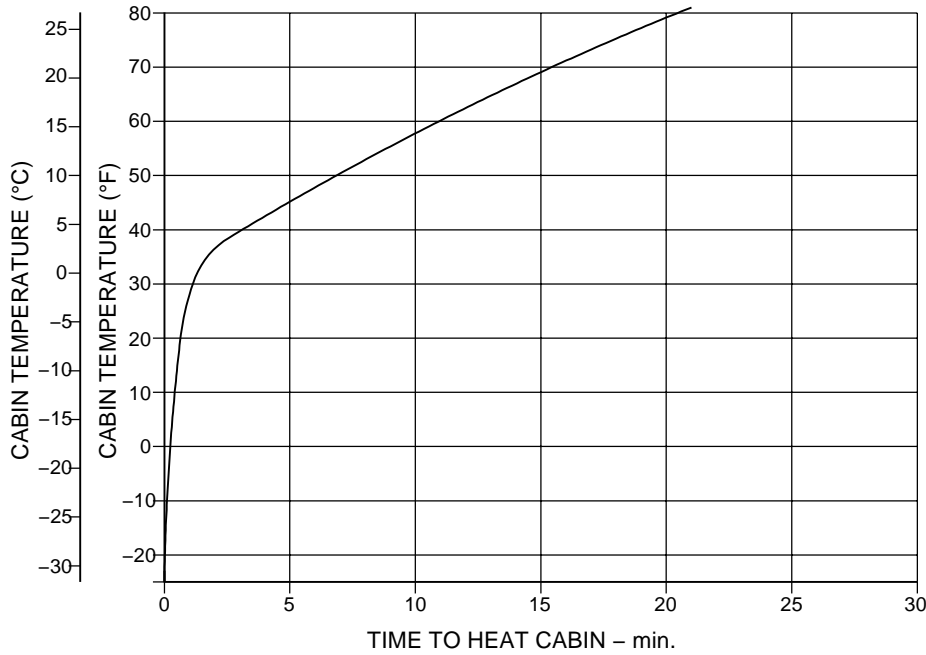

HEATING

Initial cabin temp: -32°C (-25°F)
Outside air temp: -40°C (-40°F)
Relative Humidity: 0%
No crew or passengers
No other heat load

Bleed air from APU:
87 kg/min. (192.0 lb/min.)
452 kPa (65.5 psia)
2 operating packs (ECS)

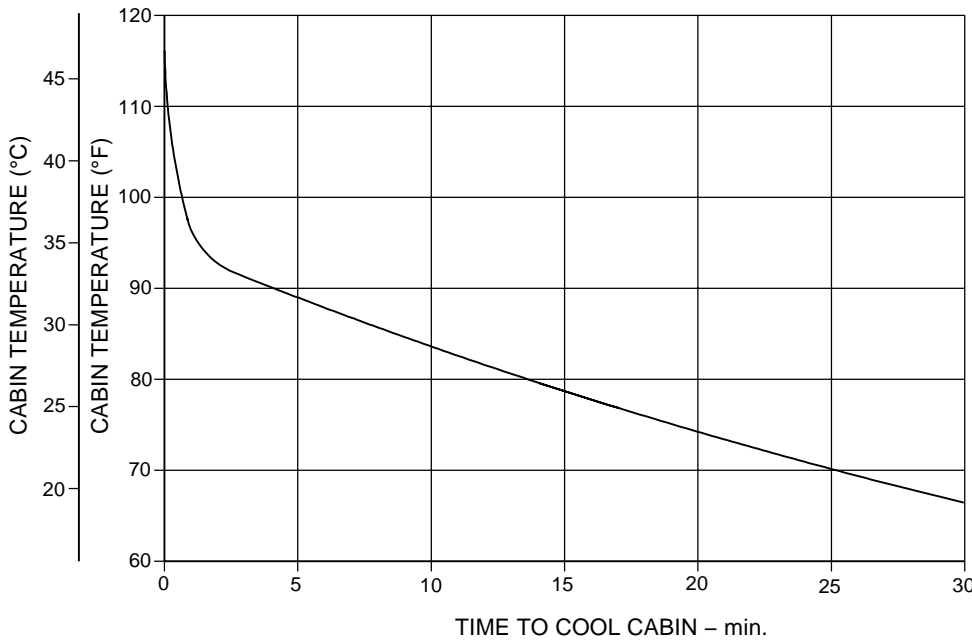

COOLING

Initial cabin temp: 47°C (116°F)
Outside air temp: 40°C (104°F)
Relative Humidity: 40%
No crew or passengers
No other heat load

Bleed air from APU:
56 kg/min. (122.9 lb/min.)
413 kPa (59.9 psia)
2 operating packs (ECS)

EM170APM050007B.DGN

**5.8. PRECONDITIONED AIRFLOW REQUIREMENTS**

This subsection presents the following information:

- The air conditioning requirements for heating and cooling using ground conditioned air. The curves show airflow requirements to heat or cool the aircraft at ambient conditions for the period of time that will be necessary.
- The air conditioning requirements for heating and cooling to maintain a constant cabin air temperature using low-pressure conditioned air. This conditioned air is supplied through a ground air connection directly to the passenger cabin, bypassing the air cycle machines.



EFFECTIVITY: ALL

Preconditioned Airflow Requirements

Figure 5.8

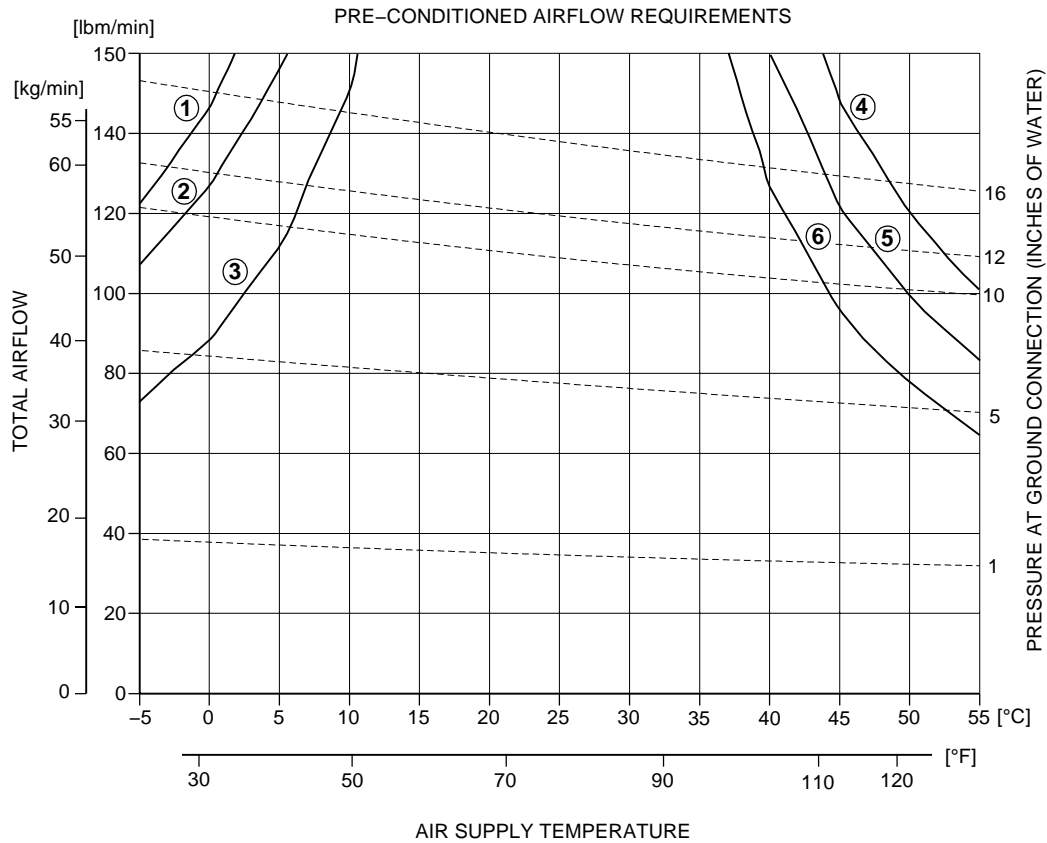

LEGEND:

- ① CABIN AT 24°C (74°F), 97 OCCUPANTS, BRIGHT DAY (SOLAR IRRADIATION), 39°C (103°F) DAY.
- ② SAME AS 1 EXCEPT CABIN 27°C (81°F)
- ③ SAME AS 1 EXCEPT CABIN 24°C (74°F), NO CABIN OCCUPANTS, FOUR CREWS MEMBERS ONLY.
- ④ CABIN AT 24°C (74°F), NO CABIN OCCUPANTS, FOUR CREW MEMBERS ONLY, OVERCAST DAY (NO SOLAR IRRADIATION), -40°C (-40°F) DAY.
- ⑤ SAME AS 4 EXCEPT -29°C (-20°F) DAY.
- ⑥ SAME AS 4 EXCEPT -18°C (-0°F) DAY.

NOTES:

MAXIMUM ALLOWABLE TEMPERATURE 88°C (190°F) (UPPER LIMIT DURING PULL UP OPERATION).

MAXIMUM ALLOWABLE PRESSURE AT GROUND CONNECTION 406mmH₂O (16 INCHES OF WATER).

EM170MFEP040070B.DGN



5.9. **GROUND TOWING REQUIREMENTS**



EFFECTIVITY: ALL
Ground Towing Requirements
Figure 5.9

GROUND PUSHBACK / TOWING REQUIREMENTS

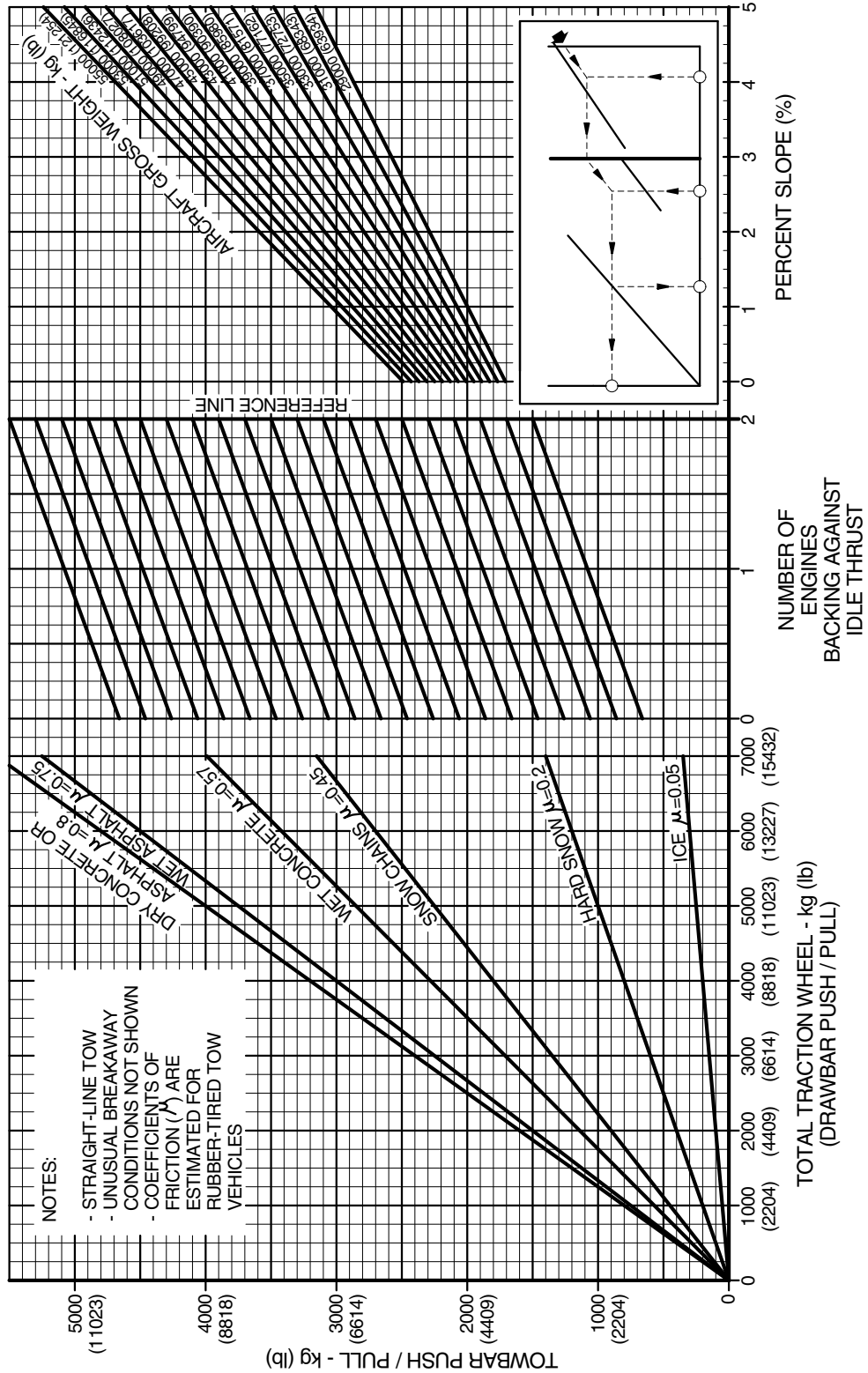

EM170MFEPO40066C.IDR



6. **OPERATING CONDITIONS**

EFFECTIVITY: ALL

6.1. **GENERAL**

This section provides the following information:

- The jet engine exhaust velocities and temperatures;
- The airport and community noise levels;
- The hazard areas.

6.2. **ENGINE EXHAUST VELOCITIES AND TEMPERATURES**



EFFECTIVITY: ALL

Jet Wake Velocity Profile - Takeoff Power

Figure 6.1

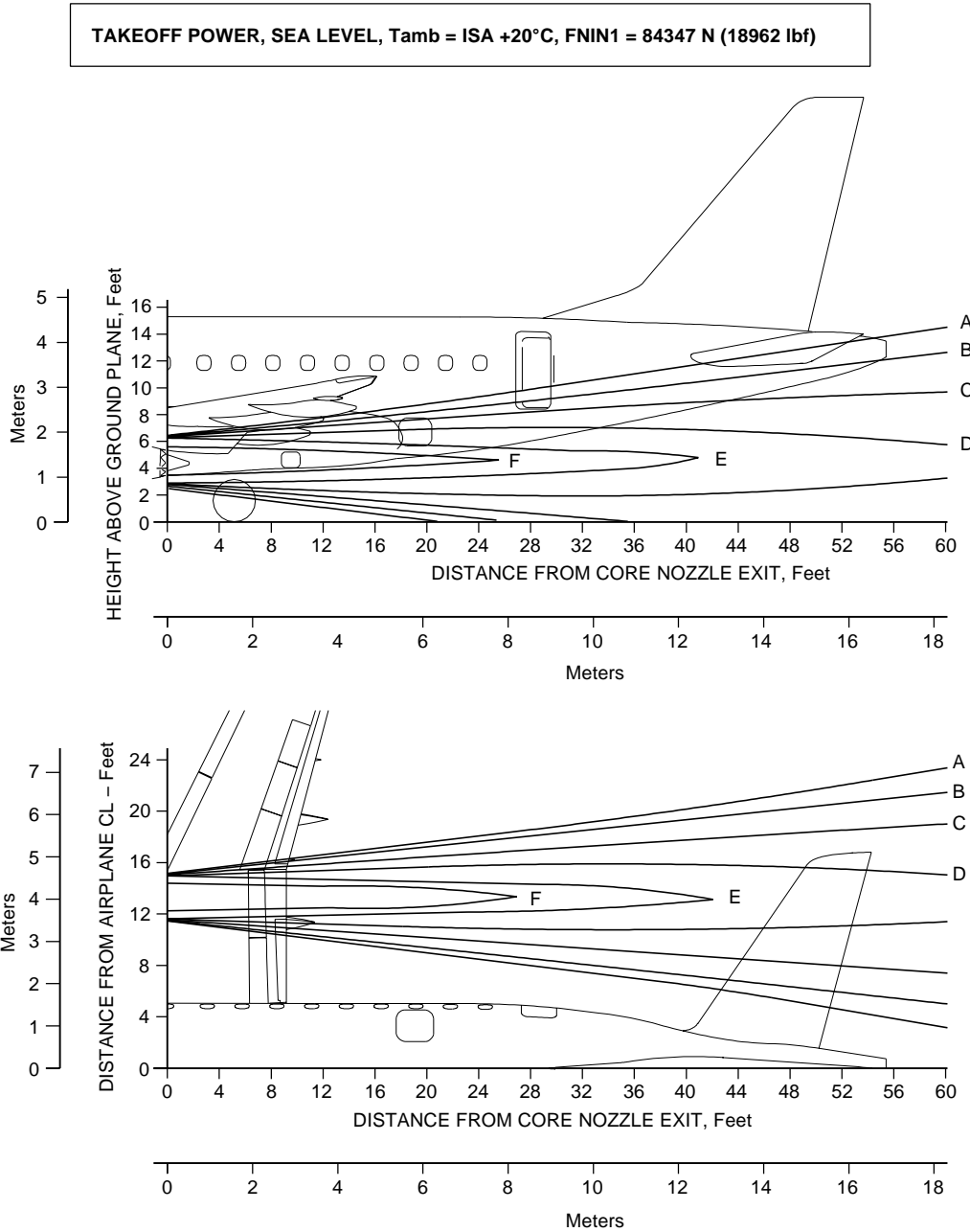

| VELOCITY m/s (ft/s) | |
|---------------------------|--------------|
| MAX = 482.5 (1583) | |
| A | 15.2 (50) |
| B | 30.5 (100) |
| C | 60.9 (200) |
| D | 121.9 (400) |
| E | 243.8 (800) |
| F | 396.2 (1300) |

NOTE:
EXHAUST VELOCITY CONTOURS INCLUDE WORST CASE 20 kn HEADWIND WITH GROUND EFFECTS.

EM170MFEP020014A.DGN



EFFECTIVITY: ALL

Jet Wake Temperature Profile - Takeoff Power

Figure 6.2

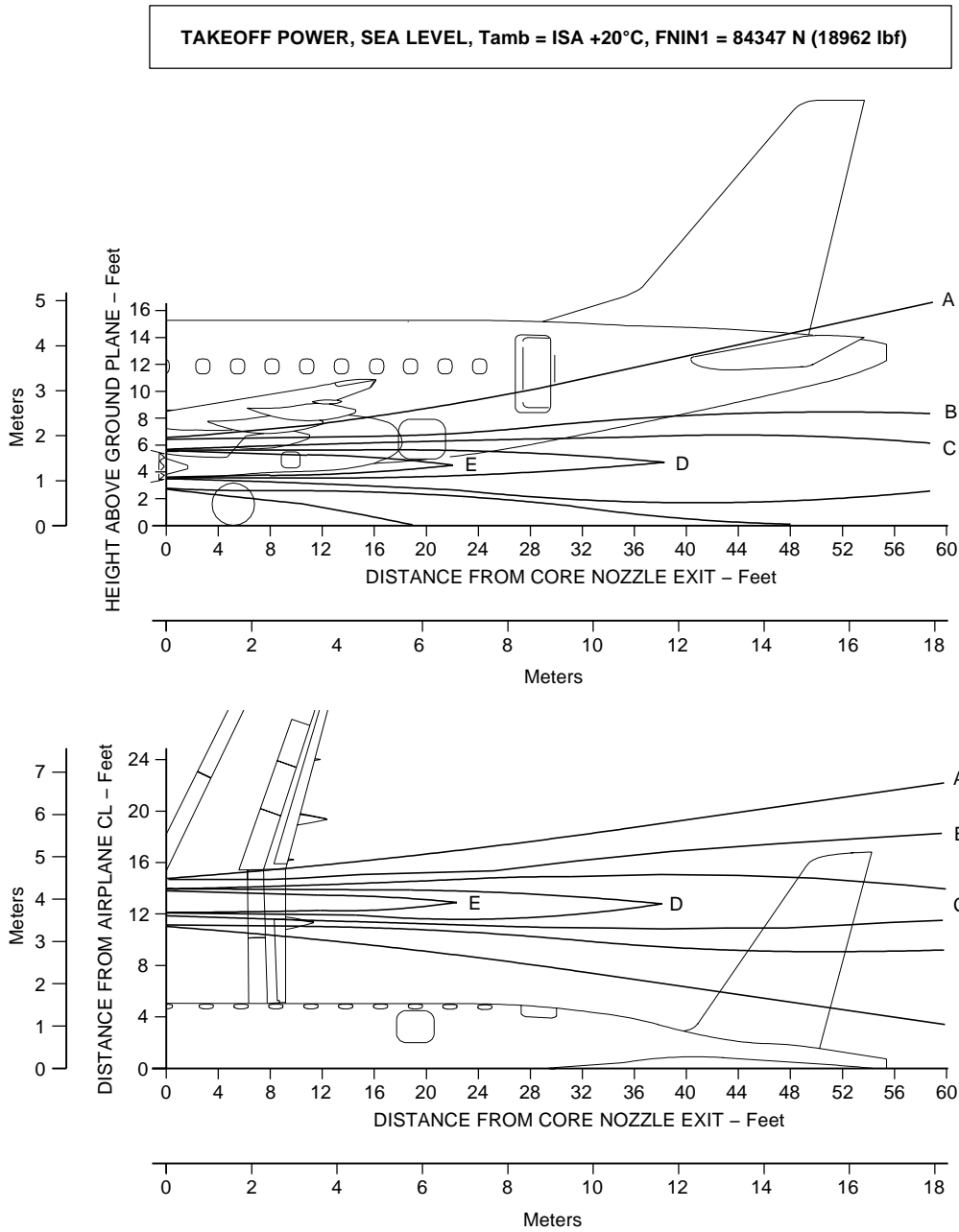

| TOTAL TEMPERATURE MAX = 689°C (1273°F) | | |
|---|-----|-----|
| | °C | °F |
| A | 38 | 100 |
| B | 66 | 150 |
| C | 93 | 200 |
| D | 204 | 400 |
| E | 582 | 900 |

NOTE:

EXHAUST TEMPERATURE CONTOURS INCLUDE WORST CASE 20 kn HEADWIND.

EM170MFEP020016B.DGN



EFFECTIVITY: ALL

Jet Wake Velocity Profile - Ground Idle

Figure 6.3

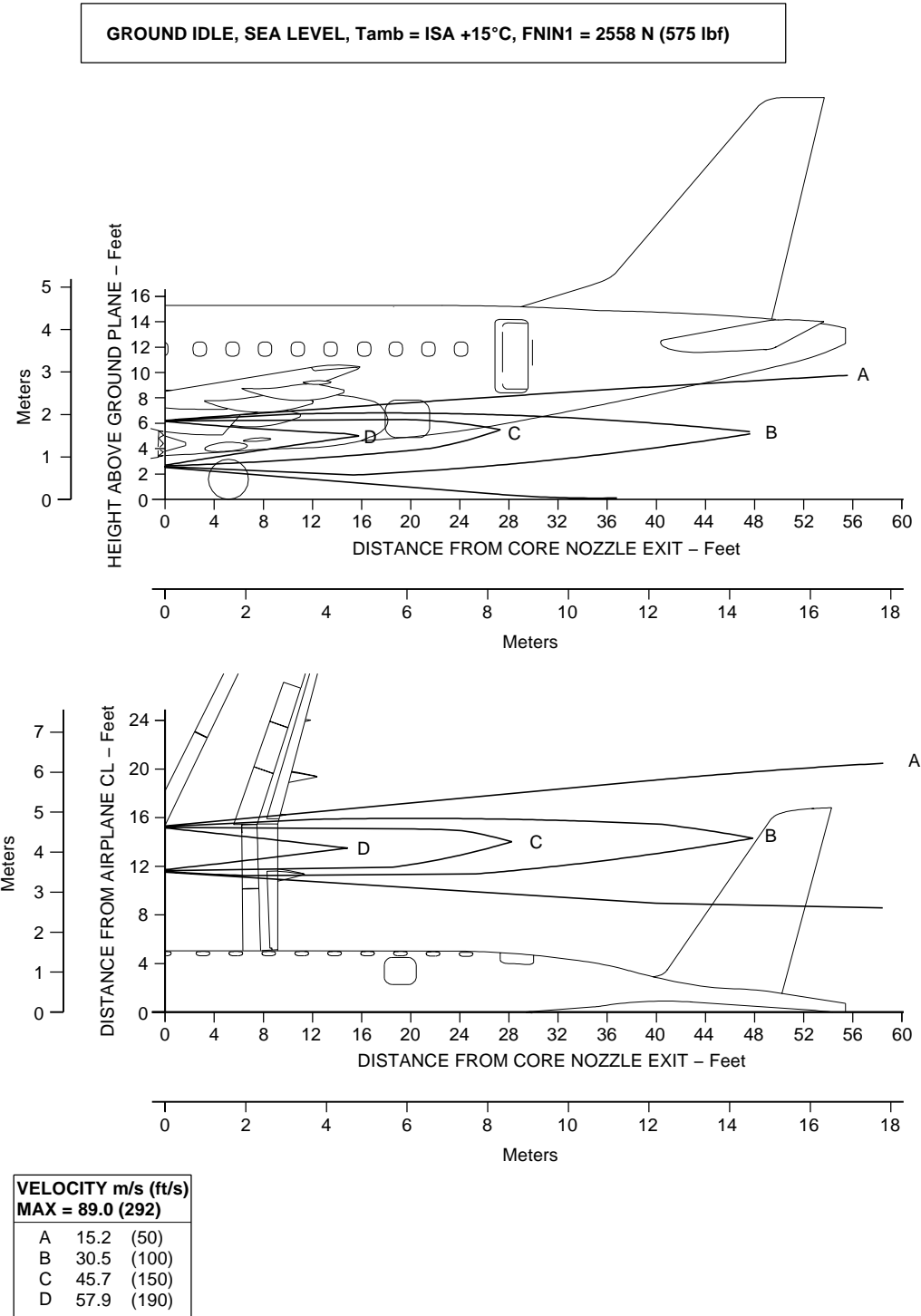

NOTE:
EXHAUST VELOCITY CONTOURS INCLUDE WORST CASE 20 kn HEADWIND WITH GROUND EFFECTS.

EM170MFEP020015A.DGN



EFFECTIVITY: ALL

Jet Wake Temperature Profile - Ground Idle

Figure 6.4

GROUND IDLE, SEA LEVEL, Tamb = ISA +15°C, FNIN1 = 2558 N (575 lbf)

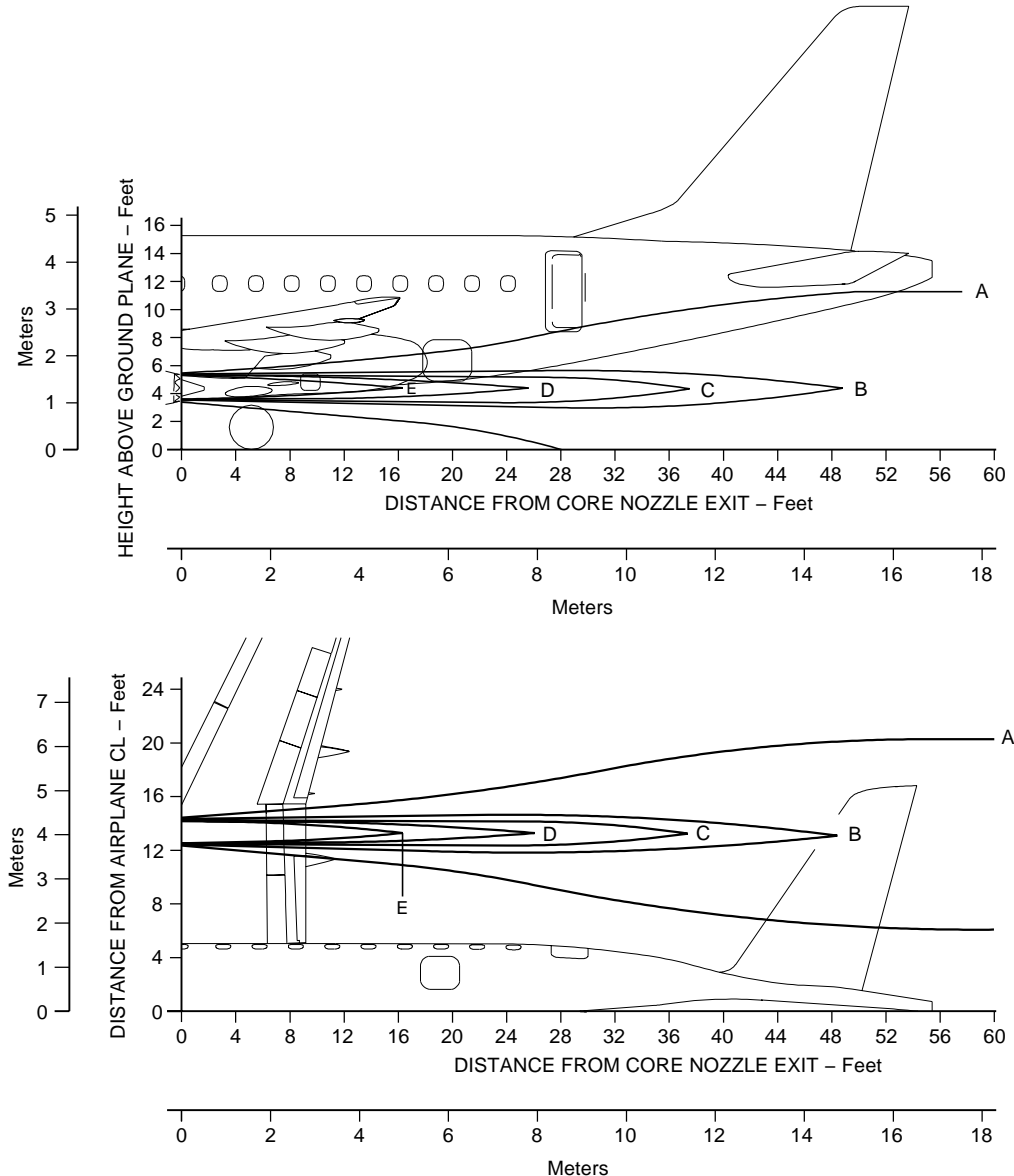

| TOTAL TEMPERATURE MAX = 519°C (966°F) | | |
|--|-----|-----|
| | °C | °F |
| A | 38 | 100 |
| B | 66 | 150 |
| C | 93 | 200 |
| D | 204 | 400 |
| E | 582 | 900 |

NOTE:

EXHAUST TEMPERATURE CONTOURS INCLUDE WORST CASE 20 kn HEADWIND.

EM170MFEP020017A.DGN



EFFECTIVITY: ALL

Jet Wake Velocity Profile - Breakaway Power

Figure 6.5 - Sheet 1

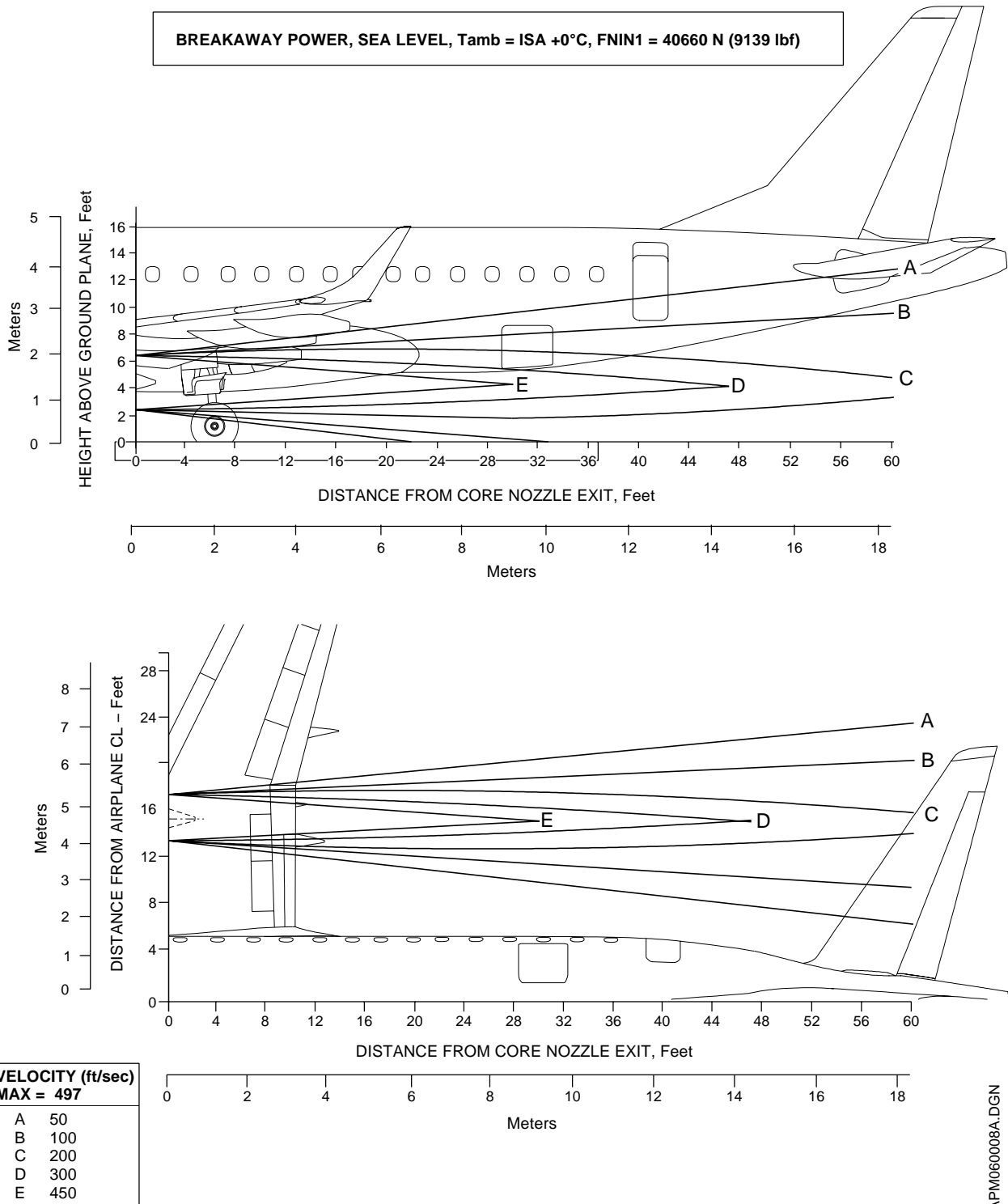



EFFECTIVITY: ALL

Jet Wake Velocity Profile - Breakaway Power

Figure 6.5 - Sheet 2

BREAKAWAY POWER, SEA LEVEL, Tamb = ISA +0°C, FNIN1 = 40660 N (9139 lbf)

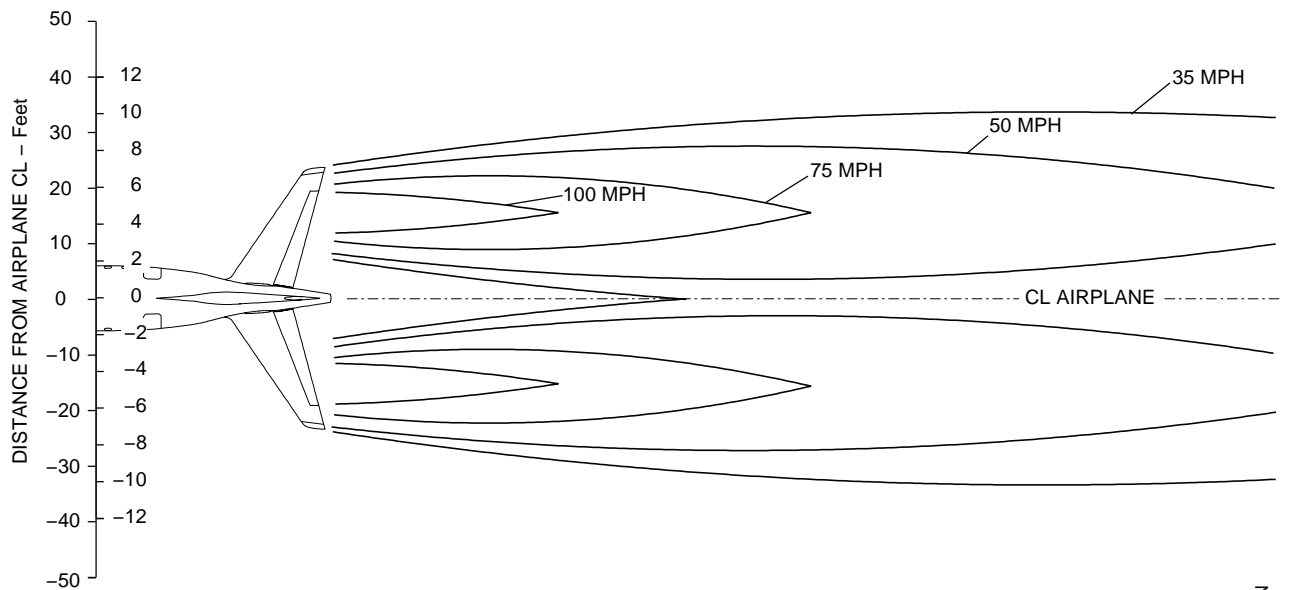
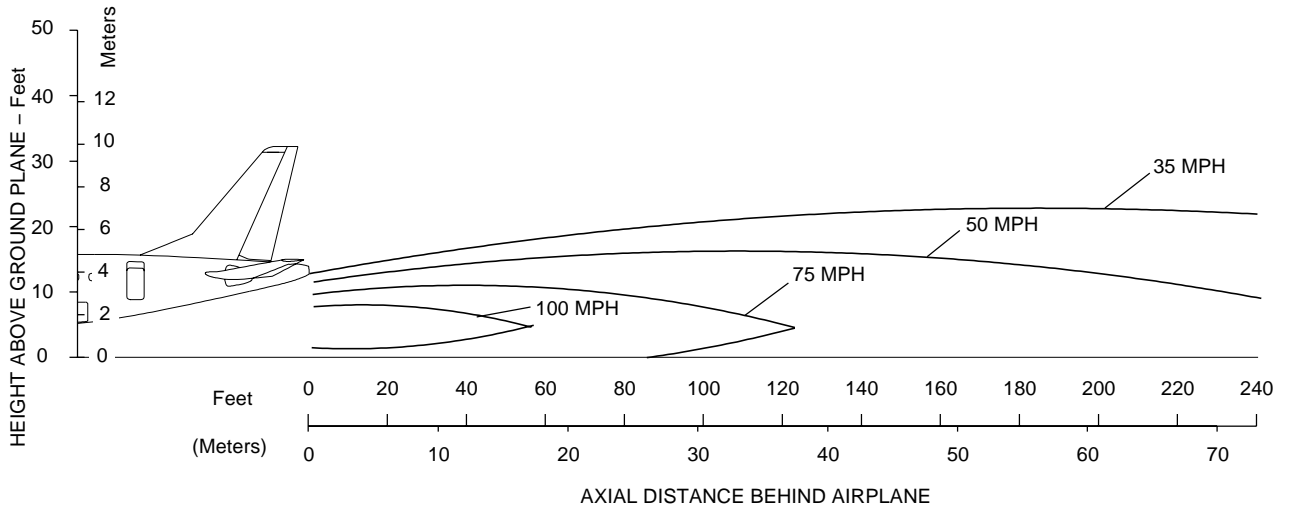

EM170APM060010A.DGN



EFFECTIVITY: ALL

Jet Wake Temperature Profile - Breakaway Power

Figure 6.6

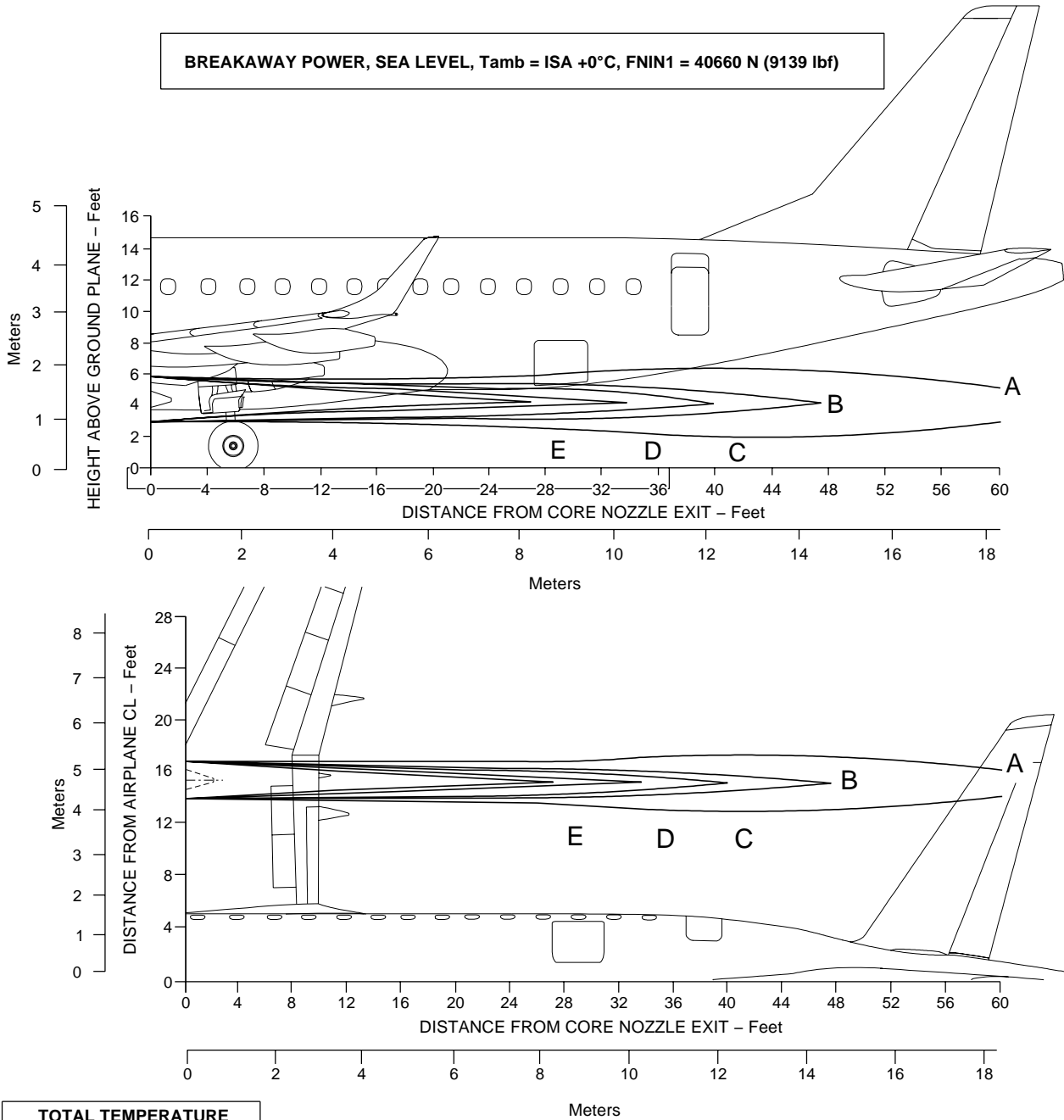

| TOTAL TEMPERATURE MAX = 697 °F (369 °C) | | |
|--|-----|-----|
| | °F | °C |
| A | 100 | 38 |
| B | 150 | 66 |
| C | 200 | 93 |
| D | 400 | 204 |
| E | 650 | 343 |

NOTE:
EXHAUST TEMPERATURE CONTOURS INCLUDE WORST CASE 20 knot HEADWIND.

EM170APM060009A.DGN

**6.3. AIRPORT AND COMMUNITY NOISE**

Aircraft noise is a major concern for the airport and community planner. The airport is a basic element in the community's transportation system and, thus, is vital to its growth. However, the airport must also be a good neighbor, and this can only be accomplished with proper planning. Since aircraft noise extends beyond the boundaries of the airport, it is vital to consider the noise impact on the surrounding communities.

Many means have been devised to provide the planner with a tool to estimate the impact of airport operations. Too often they oversimplify noise to the point where the results become erroneous. Noise is not a simple matter; therefore, there are no simple answers.

The cumulative noise contour is an effective tool. However, care must be exercised to ensure that the contours, used correctly, estimate the noise resulting from aircraft operations conducted at an airport.

The size and shape of the single-event contours, which are inputs into the cumulative noise contours, are dependent upon numerous factors. They include operational factors (aircraft weight, engine power setting, airport altitude), atmospheric conditions (wind, temperature, relative humidity, surface condition), and terrain.

6.3.1. External Certification Noise Levels

The aircraft comply with the Stage 3 / Chapter 3 noise limits set forth in 14 CFR Part 36, ICAO Annex 16, Volume 1, Chapter 3, Amendment 7 and CTA RBHA 36.

6.3.2. Ramp Noise Levels

The ramp noise will not exceed 80 dBA (maximum) and 77 dBA (average) on the rectangular perimeter of 20 m (65 ft 7 in) from the aircraft centerline, nose and tail, 90 dBA on the service positions and 80 dBA on the passenger entrance positions resulting from operation of the APU (if fitted), ECS, equipment cooling fans and vent fans, in any combination.

6.4. HAZARD AREAS



EFFECTIVITY: ALL
Hazard Areas - Takeoff Power
Figure 6.7

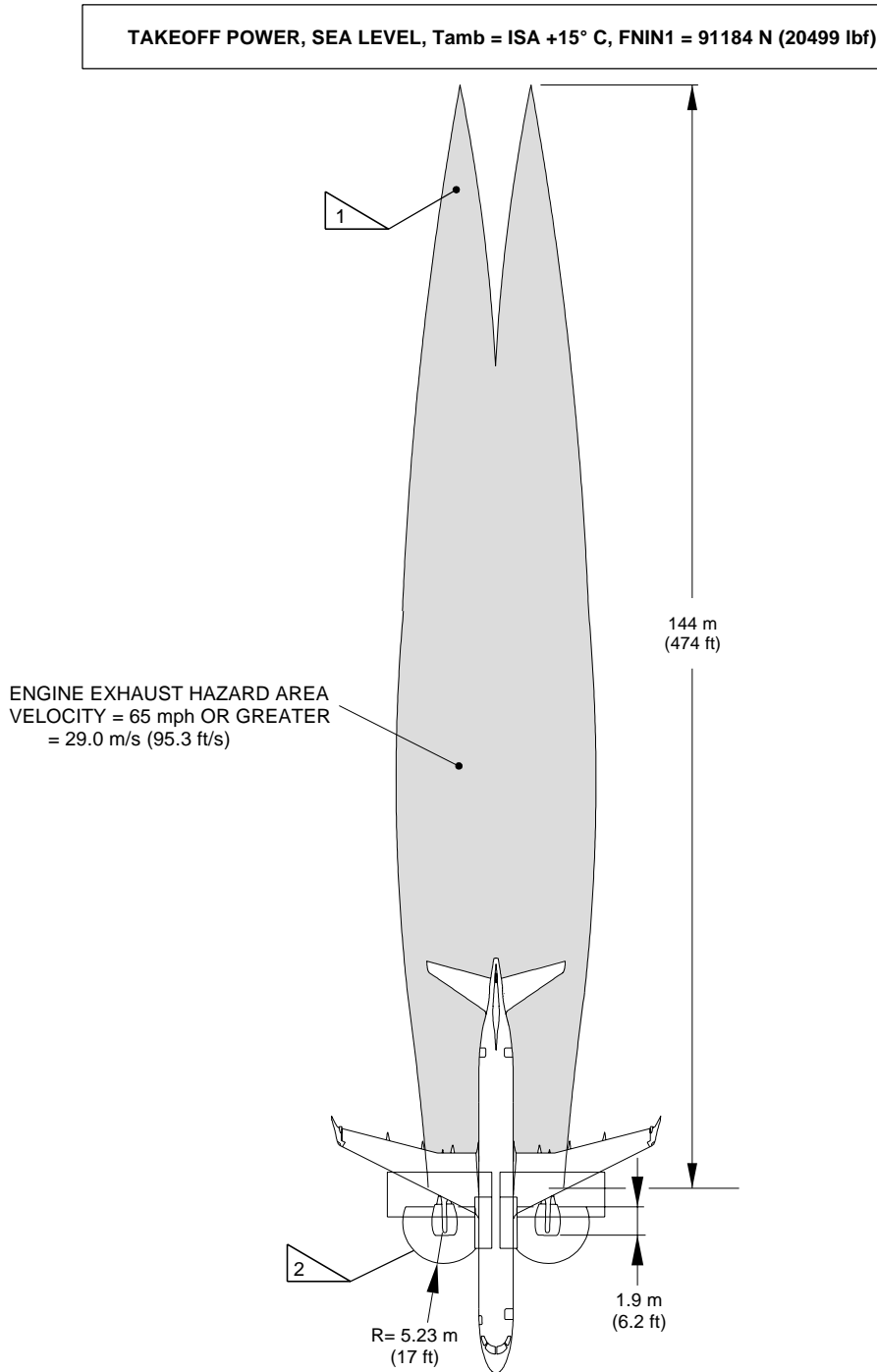

NOTE:
NO ACCESS TO ENGINE ACCESSORIES AT TAKEOFF POWER.

1 EXHAUST HAZARD AREA – CONDITION: 20 kn HEADWIND WITH GROUND EFFECTS.

2 INLET HAZARD AREA – CONDITION: 20 kn HEADWIND/CROSSWIND BASED ON 12.2 m/s (40 ft/s) CRITICAL VELOCITY WITH 0.9 m (3 ft) CONTINGENCY FACTOR.

EM170APM060004B.DGN



EFFECTIVITY: ALL

Hazard Areas - Ground Idle

Figure 6.8

GROUND IDLE, SEA LEVEL, Tamb = ISA+15° C, FNIN1 = 3768 N (847 lbf)

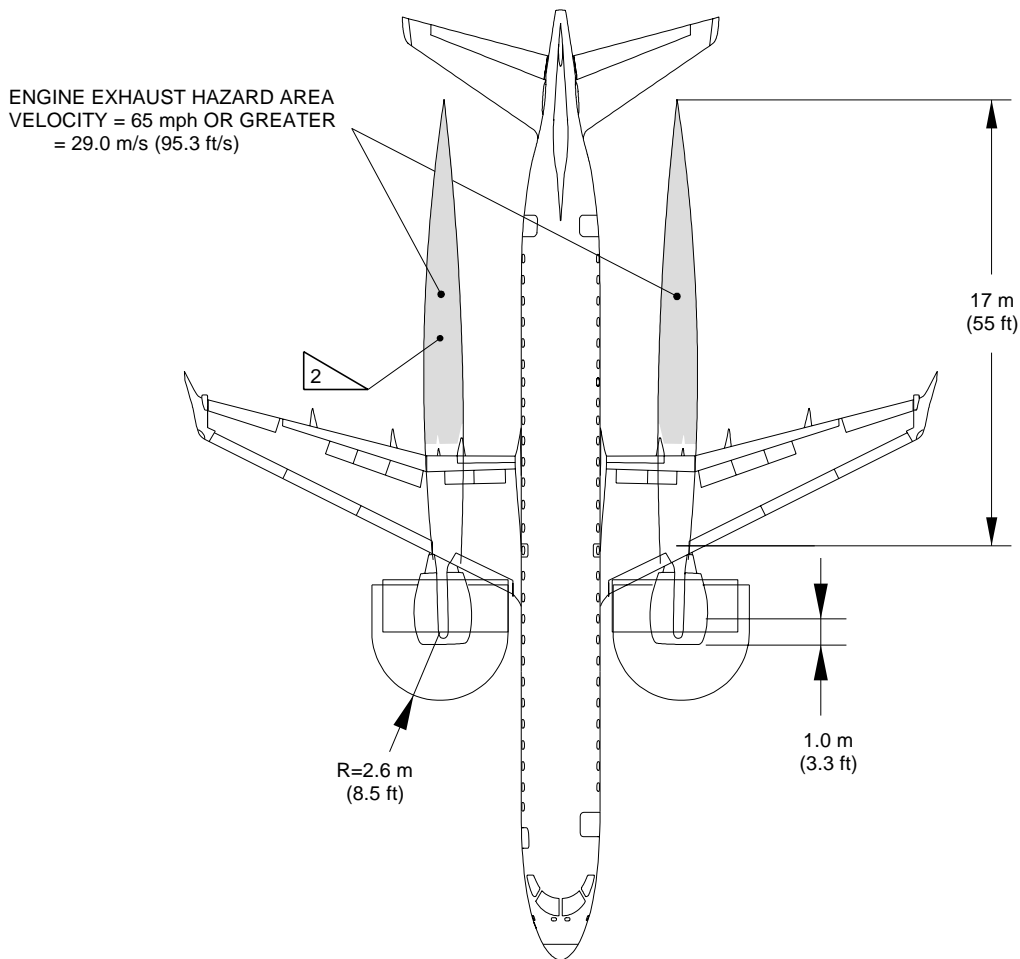

1 INLET HAZARD AREA – CONDITION: 20 kn HEADWIND/CROSSWIND/TAILWIND BASED ON 12.2 m/s (40 ft/s) CRITICAL VELOCITY WITH 0.9 m (3 ft) CONTINGENCY FACTOR.

2 EXHAUST HAZARD AREA – CONDITION: 20 kn HEADWIND WITH GROUND EFFECTS.

EM170APM060005C.DGN



7. PAVEMENT DATA*EFFECTIVITY: ALL***7.1. GENERAL INFORMATION**

Pavement is defined as a structure consisting of one or more layers of processed materials.

The primary function of a pavement is to distribute concentrated loads so that the supporting capacity of the subgrade soil is not exceeded. The subgrade soil is defined as the material on which the pavement rests, whether embankment or excavation.

Several methods for design of airport pavements have been developed that differ considerably in their approach.

The design methods are derived from observation of pavements in service or experimental pavements. Thus, the reliability of any method is proportional to the amount of experimental verification behind the method, and all methods require a considerable amount of common sense and judgment on the part of the engineer who applies them.

A brief description of the following pavement charts will be helpful in their use for airport planning. Each aircraft configuration is depicted with a minimum range of five loads imposed on the main landing gear to aid in the interpolation between the discrete values shown. The tire pressure used for the aircraft charts will produce the recommended tire deflection with the aircraft loaded to its maximum ramp weight and with center of gravity position. The tire pressure, where specifically designated in tables and on charts, are values obtained under loaded conditions as certificated for commercial use.

This section is presented as follows:

- The basic data on the landing gear footprint configuration, maximum design ramp loads, and tire sizes and pressures.
- The maximum pavement loads for certain critical conditions at the tire-ground interfaces.
- A chart in order to determine the loads throughout the stability limits of the aircraft at rest on the pavement. Pavement requirements for commercial aircraft are customarily derived from the static analysis of loads imposed on the main landing gear struts. These main landing gear loads are used to enter the pavement design charts which follow, interpolating load values where necessary.
- The flexible pavement curves prepared in accordance with the US Army Corps of Engineers Design Method and the LCN Method.
- The rigid pavement design curves in accordance with the Portland Cement Association Design Method and the LCN Method.
- The aircraft ACN values for flexible and rigid pavements.

7.2. FOOTPRINT



EFFECTIVITY: ALL
Footprint
Figure 7.1

| | AIRCRAFT MODELS | | |
|-------------------------|--|-------------------------|-------------------------|
| | STD | LR | AR |
| MAXIMUM RAMP WEIGHT | 47950 kg (105712 lb) | 50460 kg (111245 lb) | 51960 kg (114552 lb) |
| NOSE GEAR TIRE SIZE | 24 x 7.7 16PR | | |
| NOSE GEAR TIRE PRESSURE | 9.21 - 0/+0.7 kg/cm ² (131 - 0/+10 psi) | | |
| MAIN GEAR TIRE SIZE | H41 x 16-20 22PR | | |
| MAIN GEAR TIRE PRESSURE | 11.04 - 0/+0.7 kg/cm ² (157 - 0/+10 psi) | | |

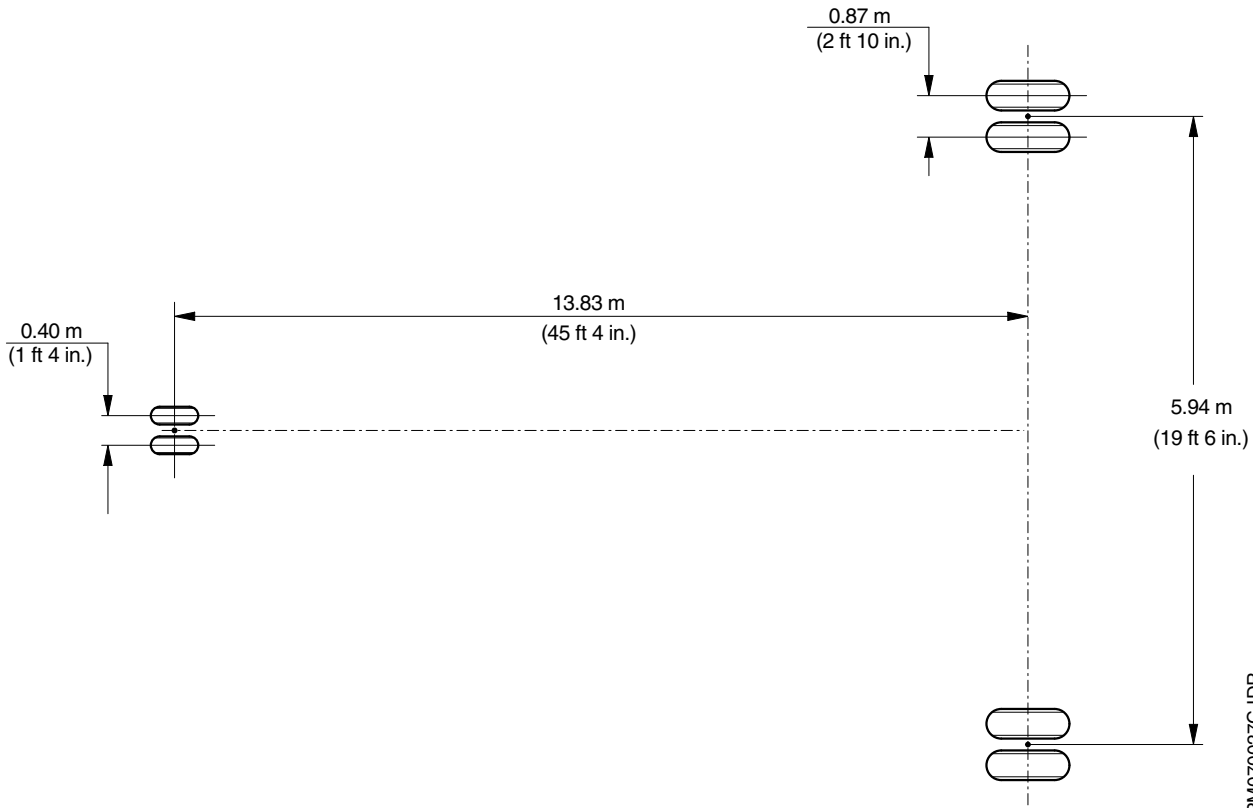

EM170APM070027C.IDR



7.3. **MAXIMUM PAVEMENT LOADS**



EFFECTIVITY: ALL
Maximum Pavement Loads
Figure 7.2

LEGEND: V_{NG} = MAXIMUM VERTICAL NOSE GEAR GROUND LOAD AT MOST FORWARD C.G.
 V_{MG} = MAXIMUM VERTICAL MAIN GEAR GROUND LOAD AT MOST FORWARD C.G.
 H = MAXIMUM HORIZONTAL GROUND LOAD FROM BRAKING

NOTE: ALL LOADS CALCULATED USING AIRCRAFT MAXIMUM RAMP WEIGHT

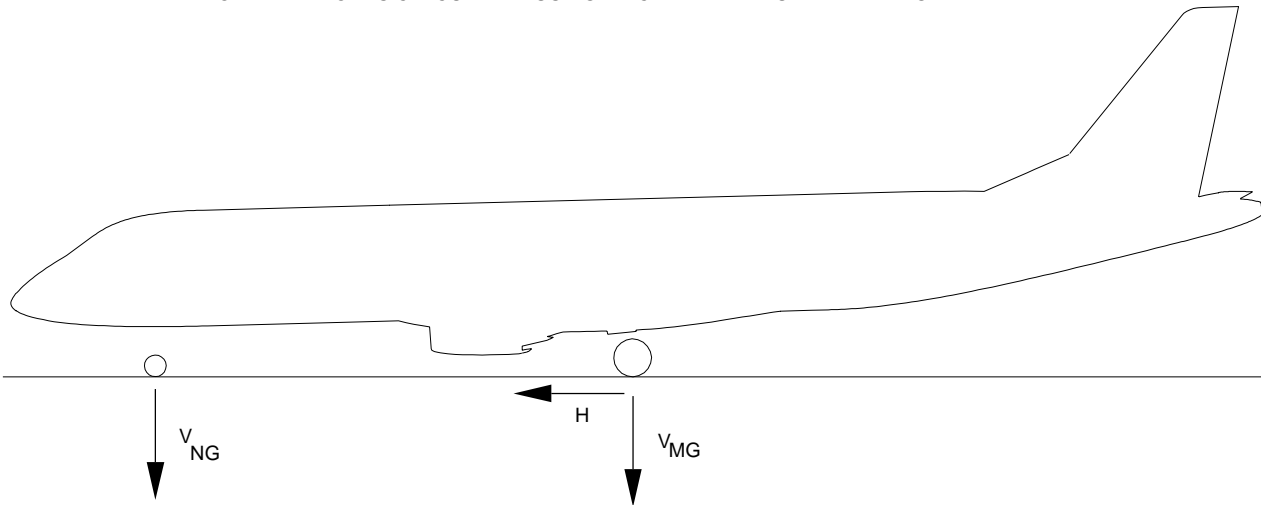

| MODEL | MAXIMUM RAMP WEIGHT | V_{NG} | | V_{MG} (PER STRUT) | H (PER STRUT) | |
|-------|-------------------------|-----------------------------|--|-------------------------|--|---|
| | | STATIC AT MOST FORWARD C.G. | STEADY BRAKING WITH DECELERATION OF 3,0 m/sec ² | STATIC AT MOST AFT C.G. | STEADY BRAKING WITH DECELERATION OF 3,0 m/sec ² | INSTANTANEOUS BRAKING (FRICTION COEF. OF 0.8) |
| LR | 50460 kg (111245 lb) | 6424 kg (14162 lb) | 8917 kg (19659 lb) | 23301 kg (51370 lb) | 6814 kg (15022 lb) | 16138 kg (35578 lb) |
| STD | 47950 kg (105712 lb) | 6470 kg (14264 lb) | 8820 kg (19445 lb) | 22213 kg (48971 lb) | 6494 kg (14317 lb) | 15376 kg (33898 lb) |
| AR | 51960 kg (114552 lb) | 6347 kg (13993 lb) | 8927 kg (19681 lb) | 23952 kg (52805 lb) | 7005 kg (15443 lb) | 16593 kg (36581 lb) |
| SR | 46150 kg (101743 lb) | 6229 kg (13732 lb) | 8498 kg (18735 lb) | 21181 kg (46696 lb) | 6255 kg (13790 lb) | 14807 kg (32644 lb) |

EM170APM070028D.DGN



7.4. **LANDING GEAR LOADING ON PAVEMENT**

**7.5. FLEXIBLE PAVEMENT REQUIREMENTS, US CORPS OF ENGINEERS DESIGN METHOD**

The flexible pavement curves that are based on procedures set forth in Instruction Report No. S-77-1, "Procedures for Development of CBR Design Curves", dated June 1977, and as modified according to the methods described in FAA Advisory Circular 150/5320-6D, "Airport Pavement Design and Evaluation", dated July 7, 1995. Instruction Report No. S-77-1 was prepared by the US Army Corps of Engineers Waterways Experiment Station, Soils and Pavements Laboratory, Vicksburg, Mississippi. The line showing 10,000 coverages is used to calculate ACN.



EFFECTIVITY: EMBRAER 190 LR ACFT MODEL

Flexible Pavement Requirements - US Army Corps of Engineers Design Method

Figure 7.4

SUBGRADE STRENGTH - CBR MODEL

- NOTES:
- TIRE SIZE: H41 x 16-20 22 PR
 - TIRE PRESSURE: 11.04 kgf/cm² (157 psi)

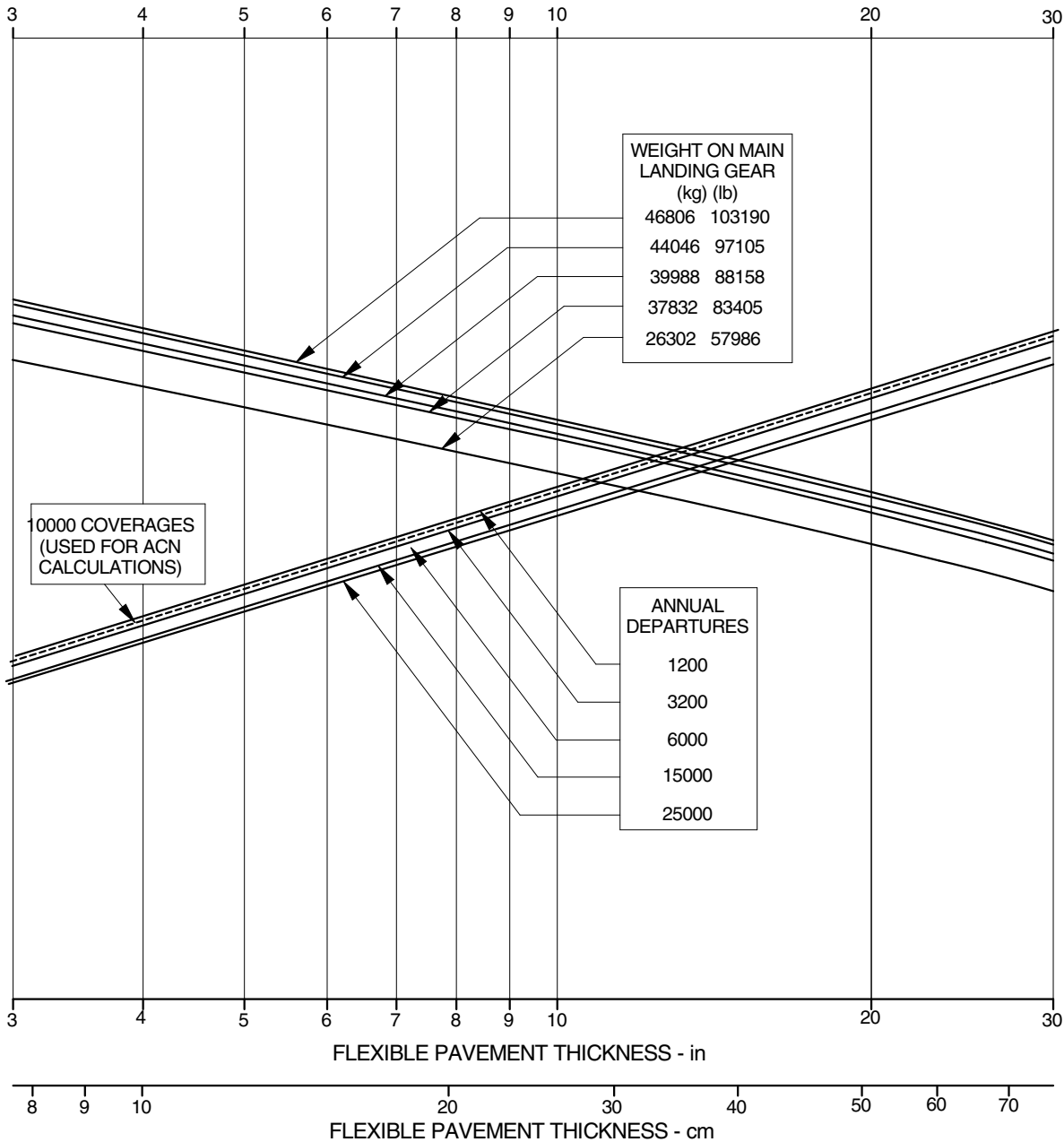
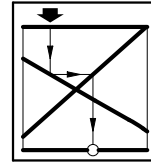

EM170APM070031B.IDR



7.6. **FLEXIBLE PAVEMENT REQUIREMENTS, LCN METHOD**

The LCN Method curves for flexible pavements. They have been built using procedures and curves in the ICAO Aerodrome Design Manual, Part 3 - Pavements, Document 9157-AN/901, 1983. The same chart includes the data of equivalent single-wheel load versus pavement thickness.



EFFECTIVITY: EMBRAER 190 LR ACFT MODEL
Flexible Pavement Requirements - LCN Method
Figure 7.5

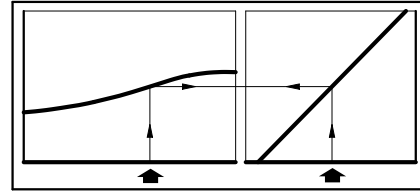

- NOTES:
- TIRE SIZE: H41x16-20 22PR₂
 - TIRE PRESSURE: 11.04 kgf/cm² (157 psi)

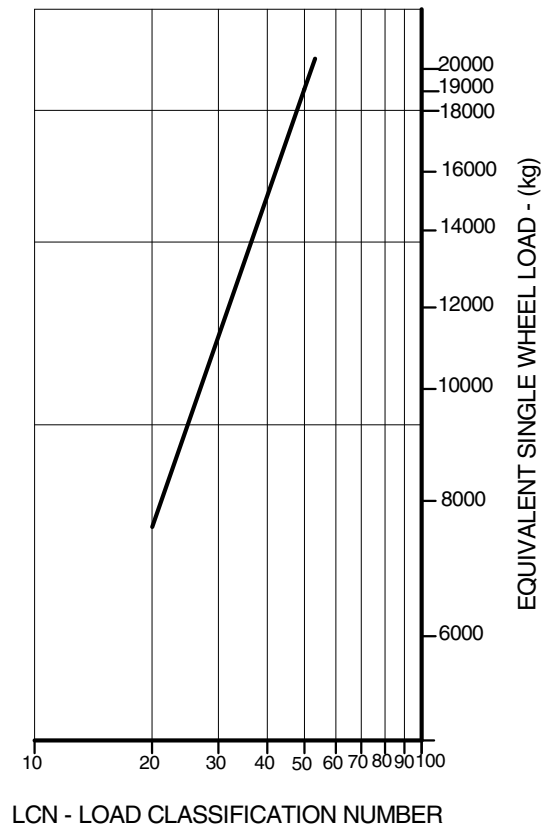
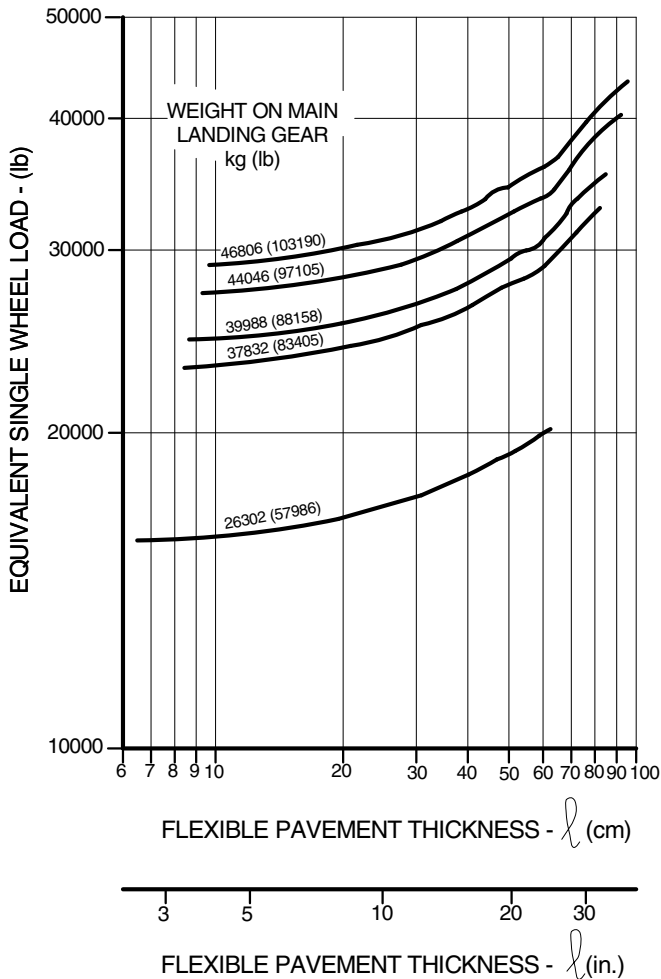

- NOTES:**
EQUIVALENT SINGLE WHEEL LOADS
ARE DERIVED BY METHODS SHOWN
IN ICAO AERODROME MANUAL.
PART 2, PAR. 4.1.3

EM170APM070033B.IDR

**7.7. RIGID PAVEMENT REQUIREMENTS, PORTLAND CEMENT ASSOCIATION DESIGN METHOD**

This method has a chart that have been prepared with the use of the Westergaard Equation in general accordance with the procedures outlined in the 1955 edition of "Design of Concrete Airport Pavement" published by the Portland Cement Association, 33 W. Grand Ave., Chicago 10, Illinois, but modified to the new format described in the 1968 Portland Cement Association publication, "Computer Program for Concrete Airport Pavement Design" by Robert G. Packard. The following procedure is used to develop rigid pavement design curves such as that shown in the chart:

- Once the scale for the pavement thickness to the left and the scale for allowable working stress to the right have been established, an arbitrary load line is drawn representing the main landing gear maximum weight to be shown.
- All values of the subgrade modulus (k-values) are then plotted.
- Additional load lines for the incremental values of weight on the main landing gear are then established on the basis of the curve for $k=300$, already established.



EFFECTIVITY: EMBRAER 190 STD ACFT MODEL

Rigid Pavement Requirements - Portland Cement Association Design Method

Figure 7.6

RIGID PAVEMENT REQUIREMENTS

- TIRE SIZE: H41 x 16-20 22PR
- TIRE PRESSURE: 10.34 kgf/cm² (147 psi) (UNLOADED)

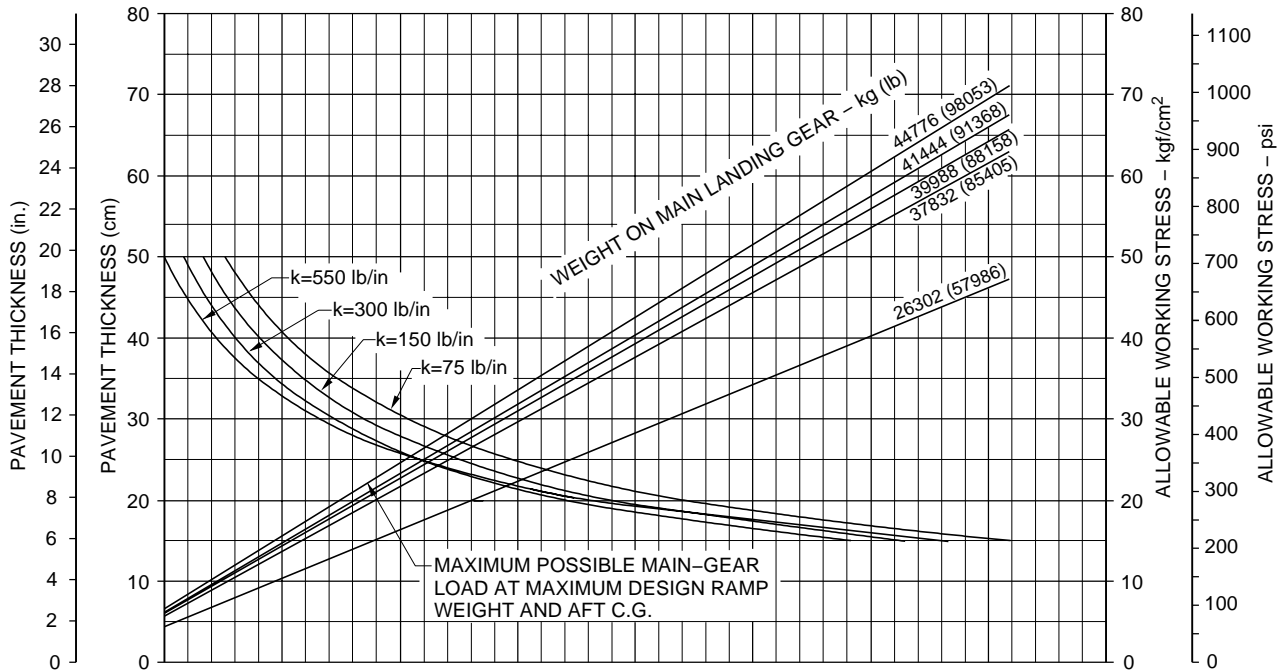
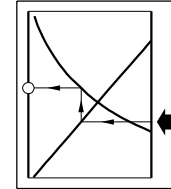

NOTE: THE VALUES OBTAINED BY USING THE MAXIMUM LOAD REFERENCE LINE AND ANY VALUE OF "K" ARE EXACT. FOR LOADS LESS THAN MAXIMUM, THE CURVES ARE EXACT FOR K=300 BUT DEVIATE SLIGHTLY FOR OTHER VALUES OF "K".

EM170APM070034A.DGN



EFFECTIVITY: EMBRAER 190 LR ACFT MODEL

Rigid Pavement Requirements - Portland Cement Association Design Method

Figure 7.7

RIGID PAVEMENT REQUIREMENTS

- NOTES:**
- TIRE SIZE: H41 x 16-20 22PR
 - TIRE PRESSURE: 11.04 kgf/cm²(157 psi) (UNLOADED)

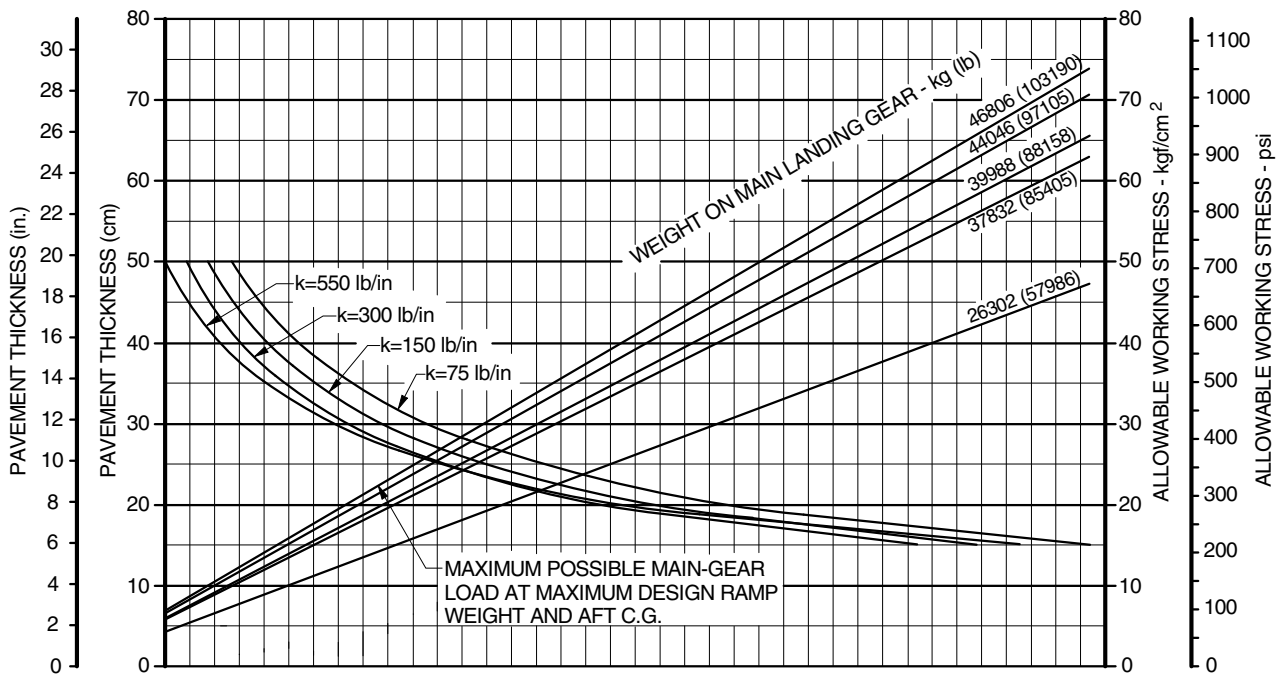
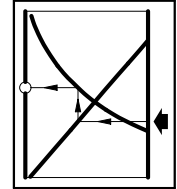

NOTE: THE VALUES OBTAINED BY USING THE MAXIMUM LOAD REFERENCE LINE AND ANY VALUE OF "K" ARE EXACT. FOR LOADS LESS THAN MAXIMUM, THE CURVES ARE EXACT FOR K=300 BUT DEVIATE SLIGHTLY FOR OTHER VALUES OF "K".

EM170APM070035B.IDR



7.8. RIGID PAVEMENT REQUIREMENTS, LCN METHOD

This LCN Method presents curves for rigid pavements. They have been built using procedures and curves in ICAO Aerodrome Design Manual, Part 3 - Pavements, Document 9157-AN/901, 1983. The same chart includes the data of equivalent single-wheel load versus radius of relative stiffness.

To determine the aircraft weight that can be accommodated on a particular rigid airport pavement, both the LCN of the pavement and the radius of relative stiffness must be known.

The radius of relative stiffness values is obtained from a table. This table presents the radius of relative stiffness values that are based on Young's modulus (E) of 4,000,000 psi and Poisson's ratio (μ) of 0.15.

For convenience in finding this radius based on other values of E and μ , the curves are included. For example, to find an RRS value based on an E of 3,000,000 psi, the "E" factor of 0.931 is multiplied by the RRS value found in figure 7.6.3. The effect of the variations of μ on the RRS value is treated in a similar manner.



EFFECTIVITY: ALL
Radius of Relative Stiffness
Figure 7.8

RADIUS OF RELATIVE STIFFNESS (ℓ)
VALUES IN INCHES

$$\ell = \sqrt[4]{\frac{Ed^3}{12(1-\mu^2)k}} = 24.1652 \sqrt[4]{\frac{d^3}{k}}$$

WHERE: E = YOUNG'S MODULUS = 4 x 10⁶ psi
k = SUBGRADE MODULUS, lb/in.³
d = RIGID-PAVEMENT THICKNESS. in.
μ = POISSON'S RATIO = 0.15

| d(in) | k=75 | k=100 | k=150 | k=200 | k=250 | k=300 | k=350 | k=400 | k=500 | k=550 |
|-------|-------|-------|-------|-------|-------|-------|-------|-------|-------|-------|
| 6.0 | 31.48 | 29.30 | 26.47 | 24.63 | 23.30 | 22.26 | 21.42 | 20.72 | 19.59 | 19.13 |
| 6.5 | 33.43 | 31.11 | 28.11 | 26.16 | 24.74 | 23.64 | 22.74 | 22.00 | 20.80 | 20.31 |
| 7.0 | 35.34 | 32.89 | 29.72 | 27.65 | 26.15 | 24.99 | 24.04 | 23.25 | 21.99 | 21.47 |
| 7.5 | 37.22 | 34.63 | 31.29 | 29.12 | 27.54 | 26.32 | 25.32 | 24.49 | 23.16 | 22.61 |
| 8.0 | 39.06 | 36.35 | 32.85 | 30.57 | 28.91 | 27.62 | 26.58 | 25.70 | 24.31 | 23.74 |
| 8.5 | 40.88 | 38.04 | 34.37 | 31.99 | 30.25 | 28.91 | 27.81 | 26.90 | 25.44 | 24.84 |
| 9.0 | 42.67 | 39.71 | 35.88 | 33.39 | 31.58 | 30.17 | 29.03 | 28.08 | 26.55 | 25.93 |
| 9.5 | 44.43 | 41.35 | 37.36 | 34.77 | 32.89 | 31.42 | 30.23 | 29.24 | 27.65 | 27.00 |
| 10.0 | 46.18 | 42.97 | 38.83 | 36.14 | 34.17 | 32.65 | 31.42 | 30.39 | 28.74 | 28.06 |
| 10.5 | 47.90 | 44.57 | 40.28 | 37.48 | 35.45 | 33.87 | 32.59 | 31.52 | 29.81 | 29.11 |
| 11.0 | 49.60 | 46.16 | 41.71 | 38.81 | 36.71 | 35.07 | 33.75 | 32.64 | 30.87 | 30.14 |
| 11.5 | 51.28 | 47.72 | 43.12 | 40.13 | 37.95 | 36.26 | 34.89 | 33.74 | 31.91 | 31.16 |
| 12.0 | 52.94 | 49.27 | 44.52 | 41.43 | 39.18 | 37.44 | 36.02 | 34.84 | 32.95 | 32.17 |
| 12.5 | 54.59 | 50.80 | 45.90 | 42.72 | 40.40 | 38.60 | 37.14 | 35.92 | 33.97 | 33.17 |
| 13.0 | 56.22 | 52.32 | 47.27 | 43.99 | 41.61 | 39.75 | 38.25 | 36.99 | 34.99 | 34.16 |
| 13.5 | 57.83 | 53.82 | 48.63 | 45.26 | 42.80 | 40.89 | 39.35 | 38.06 | 35.99 | 35.14 |
| 14.0 | 59.43 | 55.31 | 49.98 | 46.51 | 43.98 | 42.02 | 40.44 | 39.11 | 36.99 | 36.12 |
| 14.5 | 61.02 | 56.78 | 51.31 | 47.75 | 45.16 | 43.15 | 41.51 | 40.15 | 37.97 | 37.08 |
| 15.0 | 62.59 | 58.25 | 52.63 | 48.98 | 46.32 | 44.26 | 42.58 | 41.19 | 38.95 | 38.03 |
| 15.5 | 64.15 | 59.70 | 53.94 | 50.20 | 47.47 | 45.36 | 43.64 | 42.21 | 39.92 | 38.98 |
| 16.0 | 65.69 | 61.13 | 55.24 | 51.41 | 48.62 | 46.45 | 44.70 | 43.23 | 40.88 | 39.92 |
| 16.5 | 67.23 | 62.56 | 56.53 | 52.61 | 49.75 | 47.54 | 45.74 | 44.24 | 41.84 | 40.85 |
| 17.0 | 68.75 | 63.98 | 57.81 | 53.80 | 50.88 | 48.61 | 46.77 | 45.24 | 42.78 | 41.78 |
| 17.5 | 70.26 | 65.38 | 59.08 | 54.98 | 52.00 | 49.68 | 47.80 | 46.23 | 43.72 | 42.70 |
| 18.0 | 71.76 | 66.78 | 60.34 | 56.15 | 53.11 | 50.74 | 48.82 | 47.22 | 44.66 | 43.61 |
| 18.5 | 73.25 | 68.17 | 61.60 | 57.32 | 54.21 | 51.80 | 49.84 | 48.20 | 45.59 | 44.51 |
| 19.0 | 74.73 | 69.54 | 62.84 | 58.48 | 55.31 | 52.84 | 50.84 | 49.17 | 46.51 | 45.41 |
| 19.5 | 76.20 | 70.91 | 64.08 | 59.63 | 56.39 | 53.88 | 51.84 | 50.14 | 47.42 | 46.30 |
| 20.0 | 77.66 | 72.27 | 65.30 | 60.77 | 57.47 | 54.91 | 52.84 | 51.10 | 48.33 | 47.19 |
| 20.5 | 79.11 | 73.62 | 66.52 | 61.91 | 58.55 | 55.94 | 53.83 | 52.06 | 49.23 | 48.07 |
| 21.0 | 80.55 | 74.96 | 67.74 | 63.04 | 59.62 | 56.96 | 54.81 | 53.01 | 50.13 | 48.95 |
| 21.5 | 81.99 | 76.30 | 68.94 | 64.16 | 60.68 | 57.97 | 55.78 | 53.95 | 51.02 | 49.82 |
| 22.0 | 83.41 | 77.63 | 70.14 | 65.28 | 61.73 | 58.98 | 56.75 | 54.89 | 51.91 | 50.69 |
| 22.5 | 84.83 | 78.95 | 71.34 | 66.38 | 62.78 | 59.99 | 57.72 | 55.82 | 52.79 | 51.55 |
| 23.0 | 86.24 | 80.26 | 72.52 | 67.49 | 63.83 | 60.98 | 58.68 | 56.75 | 53.67 | 52.41 |
| 23.5 | 87.64 | 81.56 | 73.70 | 68.59 | 64.86 | 61.97 | 59.63 | 57.67 | 54.54 | 53.26 |
| 24.0 | 89.04 | 82.86 | 74.87 | 69.68 | 65.90 | 62.96 | 60.58 | 58.59 | 55.41 | 54.11 |
| 24.5 | 90.43 | 84.15 | 76.04 | 70.76 | 66.92 | 63.94 | 61.52 | 59.50 | 56.28 | 54.95 |
| 25.0 | 91.81 | 85.44 | 77.20 | 71.84 | 67.95 | 64.92 | 62.46 | 60.41 | 57.14 | 55.79 |

EM170APM070007.DGN



EFFECTIVITY: ALL

Radius of Relative Stiffness (other values)

Figure 7.9

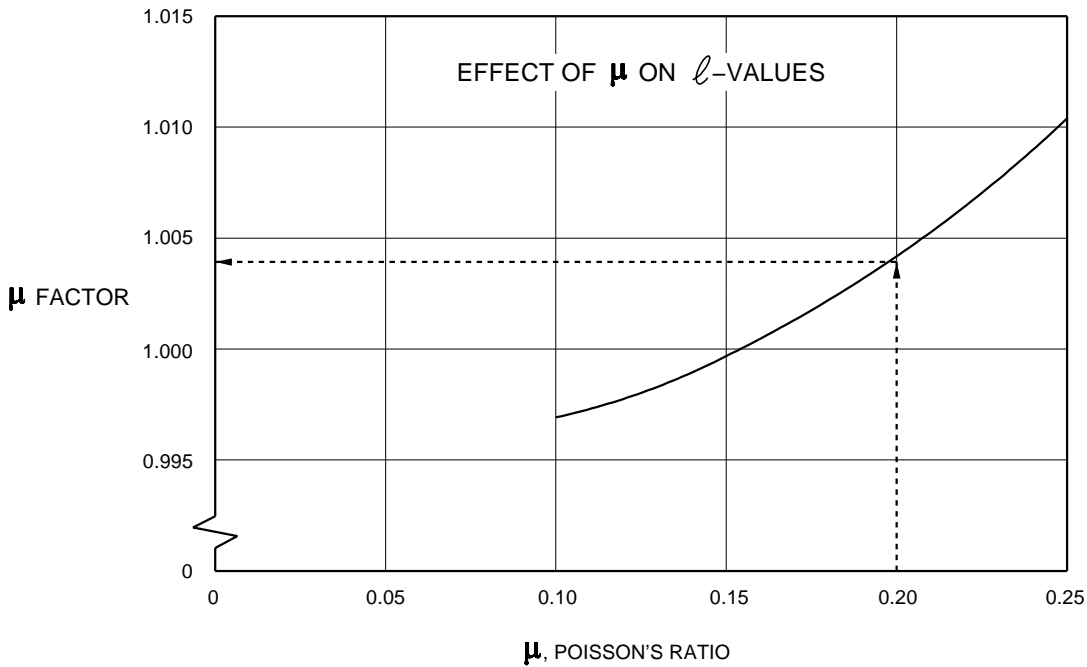
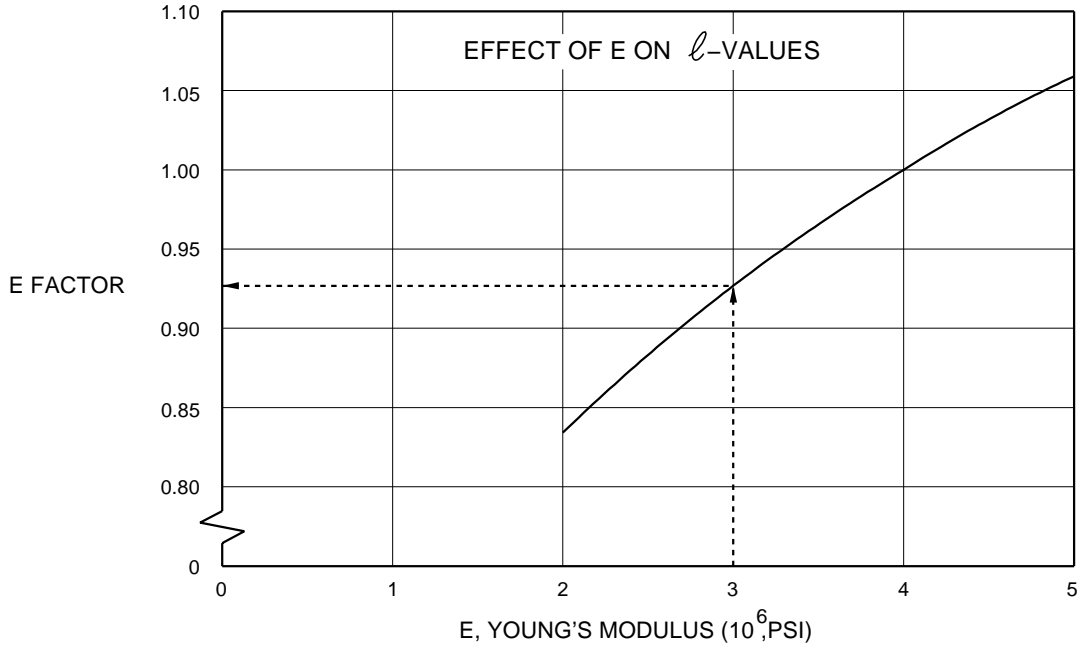

NOTE: BOTH CURVES ON THIS PAGE ARE USED TO ADJUST THE l -VALUES.

EM170APM070008.DGN



EFFECTIVITY: EMBRAER 190 STD ACFT MODEL
Rigid Pavement Requirements - LCN Method
Figure 7.10

- NOTES:
- TIRE SIZE: H41 x 16-20 22 PR₂
 - TIRE PRESSURE: 10.34 kgf/cm² (147 psi)

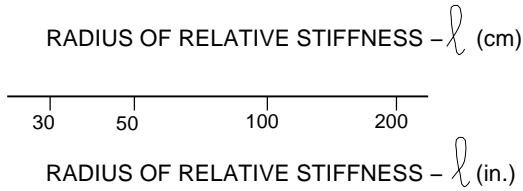
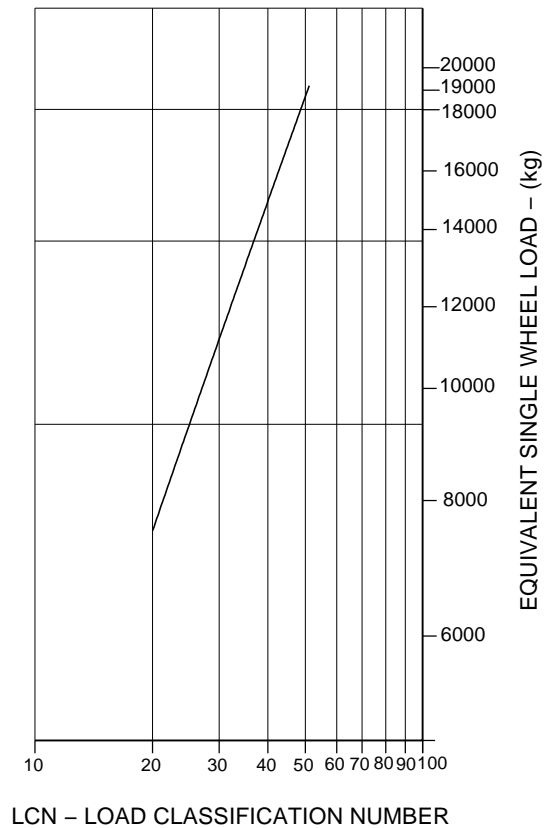
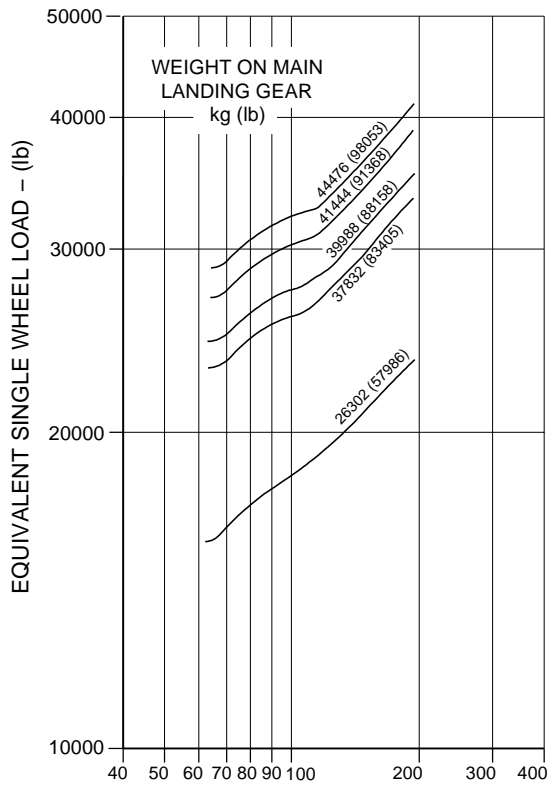
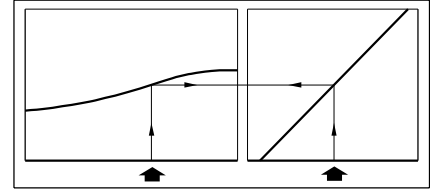

NOTES:
EQUIVALENT SINGLE WHEEL LOADS
ARE DERIVED BY METHODS SHOWN
IN ICAO AERODROME MANUAL,
PART 2, PAR. 4.1.3

EM170APM070036A.DGN



EFFECTIVITY: EMBRAER 190 LR ACFT MODEL
Rigid Pavement Requirements - LCN Method
Figure 7.11

- NOTES:
- TIRE SIZE: H41 x 16-20 22 PR
 - TIRE PRESSURE: 11.04 kgf/cm² (157 psi)

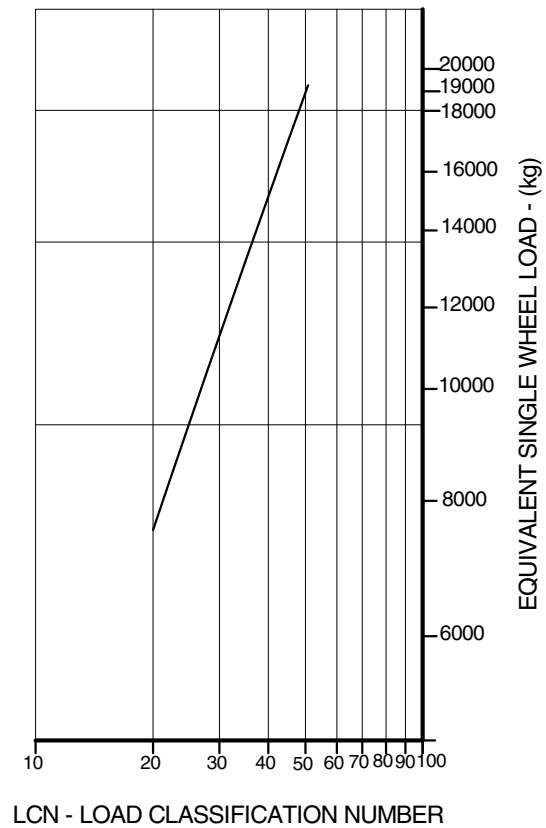
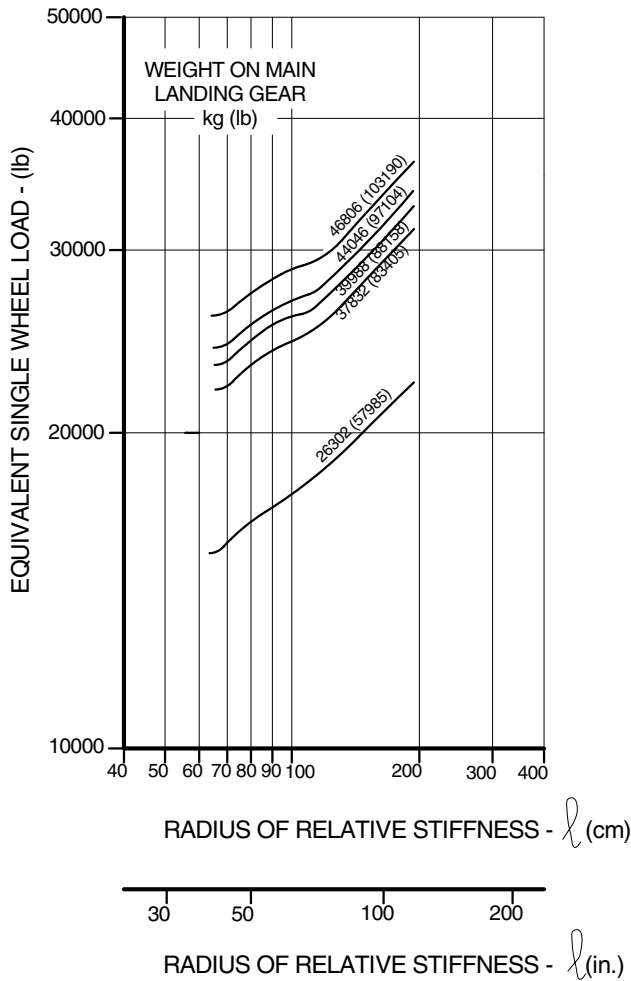
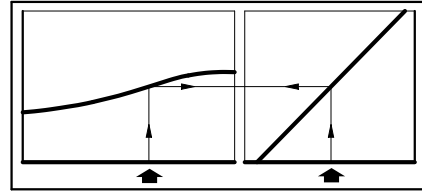

NOTES:
EQUIVALENT SINGLE WHEEL LOADS
ARE DERIVED BY METHODS SHOWN
IN ICAO AERODROME MANUAL,
PART 2, PAR. 4.1.3

EM170APM070037B.IDR



7.9. ACN - PCN SYSTEM - FLEXIBLE AND RIGID PAVEMENTS

The ACN/PCN system as referenced in Amendment 35 to ICAO Annex 14, "Aerodromes", provides a standardized international aircraft/pavement rating system.

The PCN is an index rating of the mass which an evaluation shows can be borne by the pavement when applied by a standard single wheel. The ACN established for the particular pavement type and subgrade category of the rated pavement as well as for the particular aircraft mass and characteristics.

An aircraft shall be have an ACN equal to or less than the PCN to operate without restriction on the pavement.

The method of pavement evaluation is left up to the airport with the results of their evaluation presented as follows:

Table 7.1 - Pavement Evaluation

| PAVEMENT TYPE | SUBGRADE CATEGORY | TIRE PRESSURE CATEGORY | METHOD |
|---|--------------------------|-------------------------------|--------------------|
| R – Rigid | A – High | W – No Limit | T – Technical |
| F – Flexible | B – Medium | X – to 1.75 Mpa (254 psi) | U – Using aircraft |
| | C – Low | Y – to 1.25 Mpa (181 psi) | |
| | D – Ultra Low | Z – to 0.5 Mpa (73 psi) | |
| Report example: PCN 80/R/B/X/T, where: | | | |
| 80 = PCN | | | |
| R = Pavement Type: Rigid | | | |
| B = Subgrade Category: Medium | | | |
| X = Tire Pressure Category: Medium (limited to 1.5 Mpa) | | | |
| T = Evaluation Method: Technical | | | |

The flexible pavements have four subgrade categories:

- A. High Strength - CBR 15.
- B. Medium Strength - CBR 10.
- C. Low Strength - CBR 6.
- D. Ultra Low Strength - CBR 3.

The rigid pavements have four subgrade categories:

- A. High Strength - Subgrade k = 150 MN/m³ (550 lb/in³).
- B. Medium Strength - k = 80 MN/m³ (300 lb/in³).
- C. Low Strength - k = 40 MN/m³ (150 lb/in³).
- D. Ultra Low Strength - k = 20 MN/m³ (75 lb/in³).



EFFECTIVITY: EMBRAER 190 STD ACFT MODEL
ACN For Flexible Pavement
Figure 7.12

FLEXIBLE PAVEMENT SUBGRADE

- NOTES:**
- TIRE SIZE: H41 x 16-20 22PR
 - TIRE PRESSURE: 10.34 kgf/cm²(157 psi) (UNLOADED)

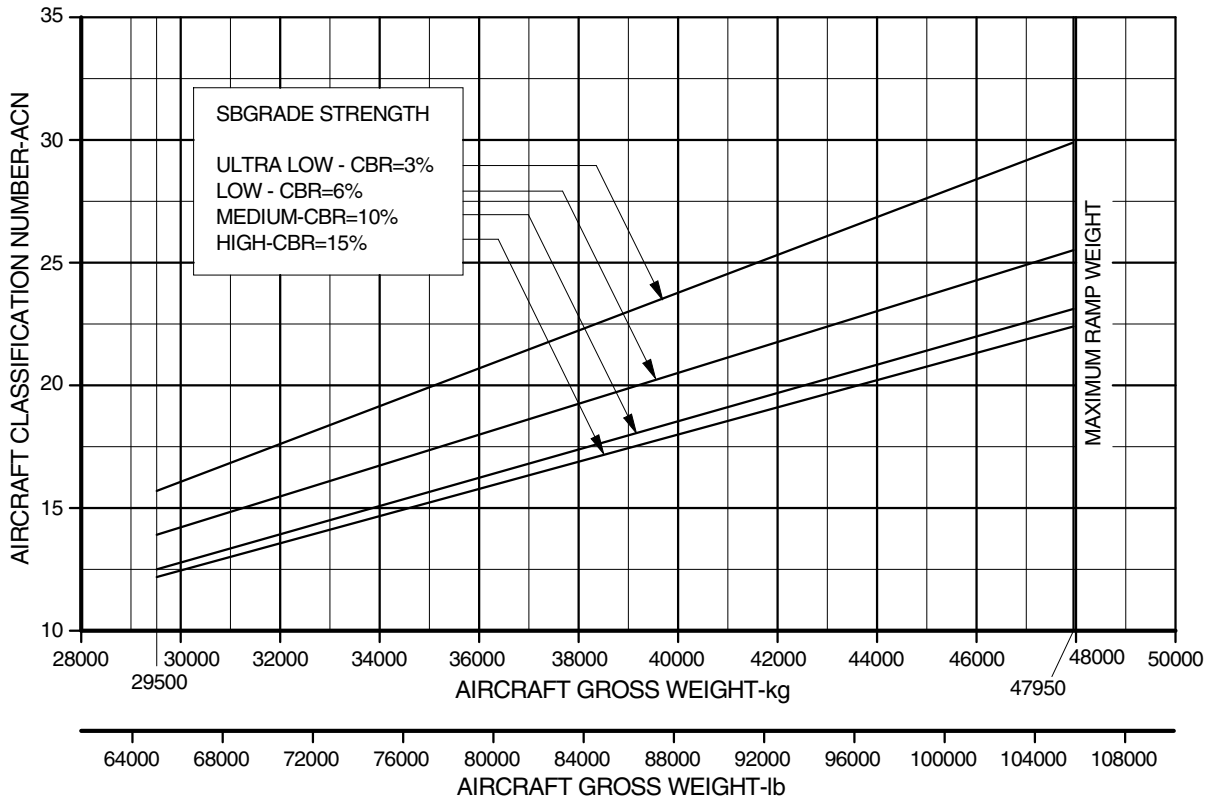
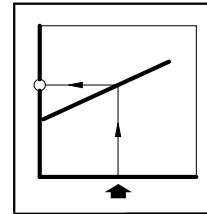

EM170APM070038B.IDR



EFFECTIVITY: EMBRAER 190 LR ACFT MODEL
ACN For Flexible Pavement
Figure 7.13

FLEXIBLE PAVEMENT SUBGRADE

- NOTES:
- TIRE SIZE: H41 x 16-20 22 PR₂
 - TIRE PRESSURE: 11.04 kgf/cm² (157 psi) (UNLOADED)

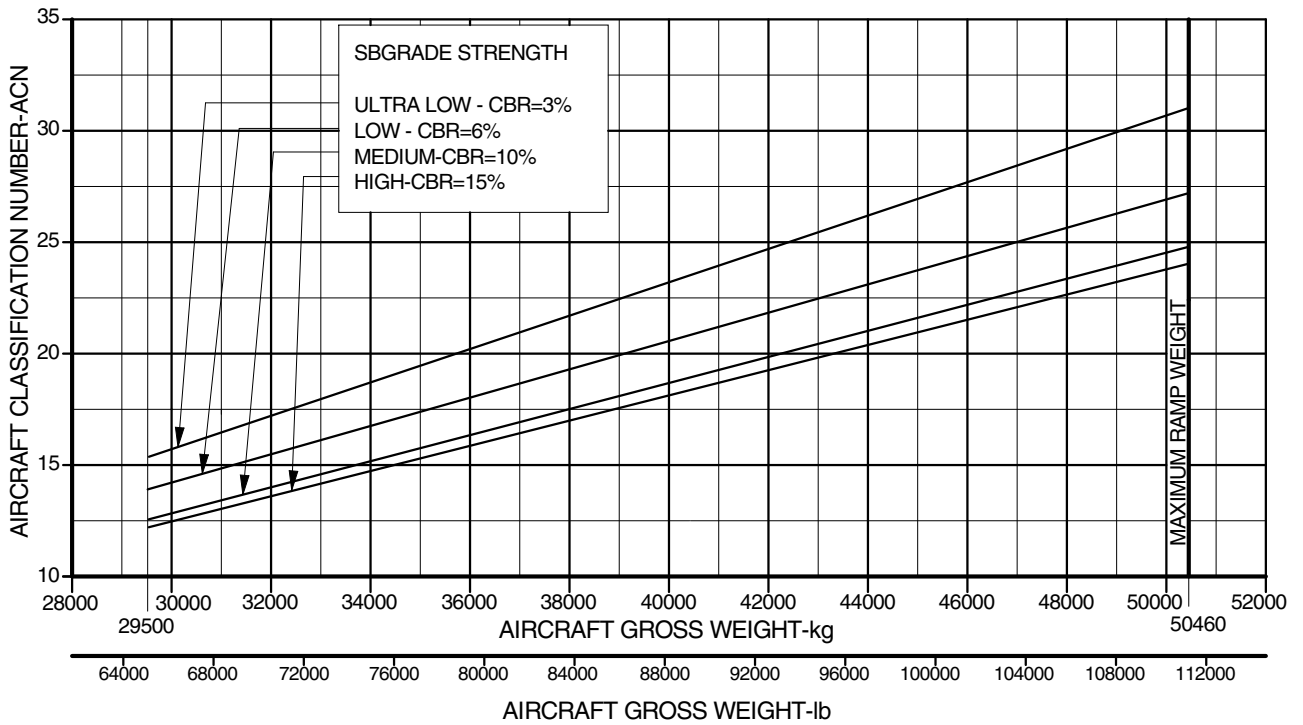
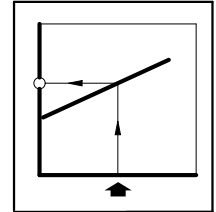

EM170APM070039C.IDR



EFFECTIVITY: EMBRAER 190 STD ACFT MODEL
ACN For Rigid Pavement
Figure 7.14

RIGID PAVEMENT SUBGRADE

- NOTES:
- TIRE SIZE: H41 x 16-20 22 PR
 - TIRE PRESSURE: 10.34 kgf/cm² (157 psi) (UNLOADED)

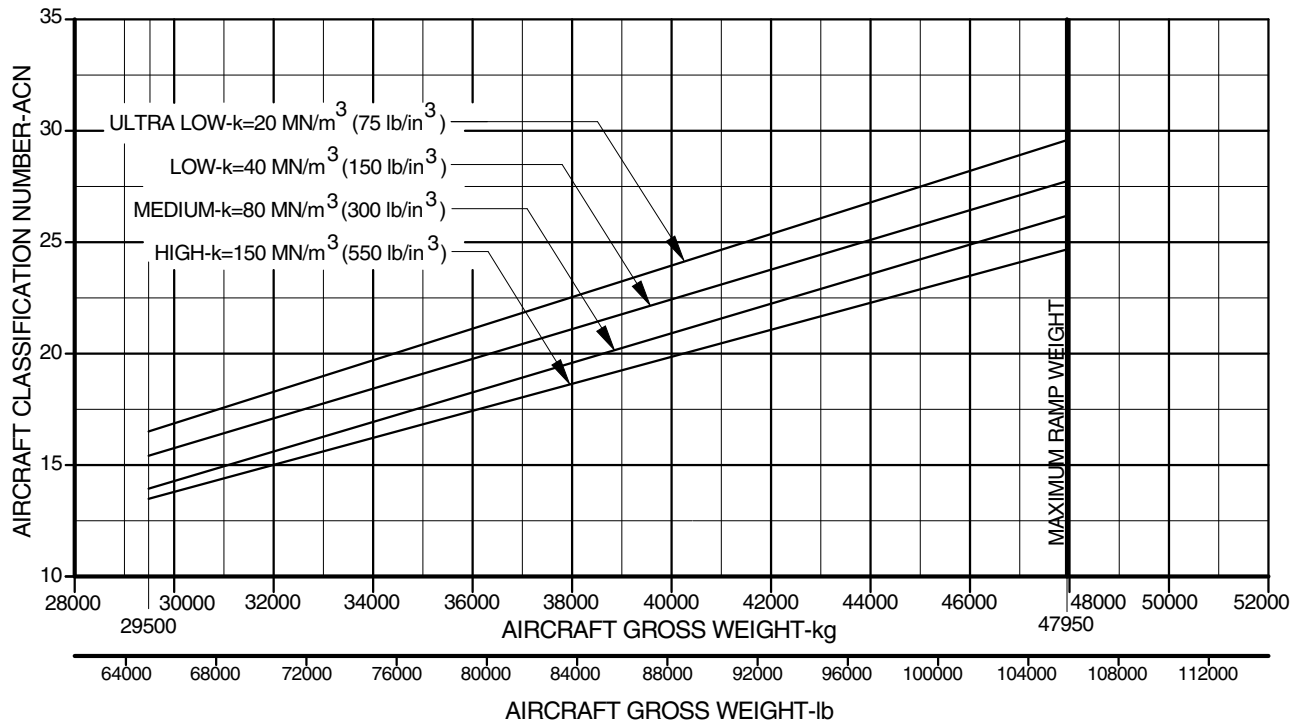
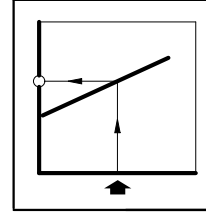

EM170APM070040B.IDR



EFFECTIVITY: EMBRAER 190 LR ACFT MODEL
ACN For Rigid Pavement
Figure 7.15

RIGID PAVEMENT SUBGRADE

- NOTES:
- TIRE SIZE: H41 x 16-20 22 PR₂
 - TIRE PRESSURE: 11.04 kgf/cm² (157 psi) (UNLOADED)

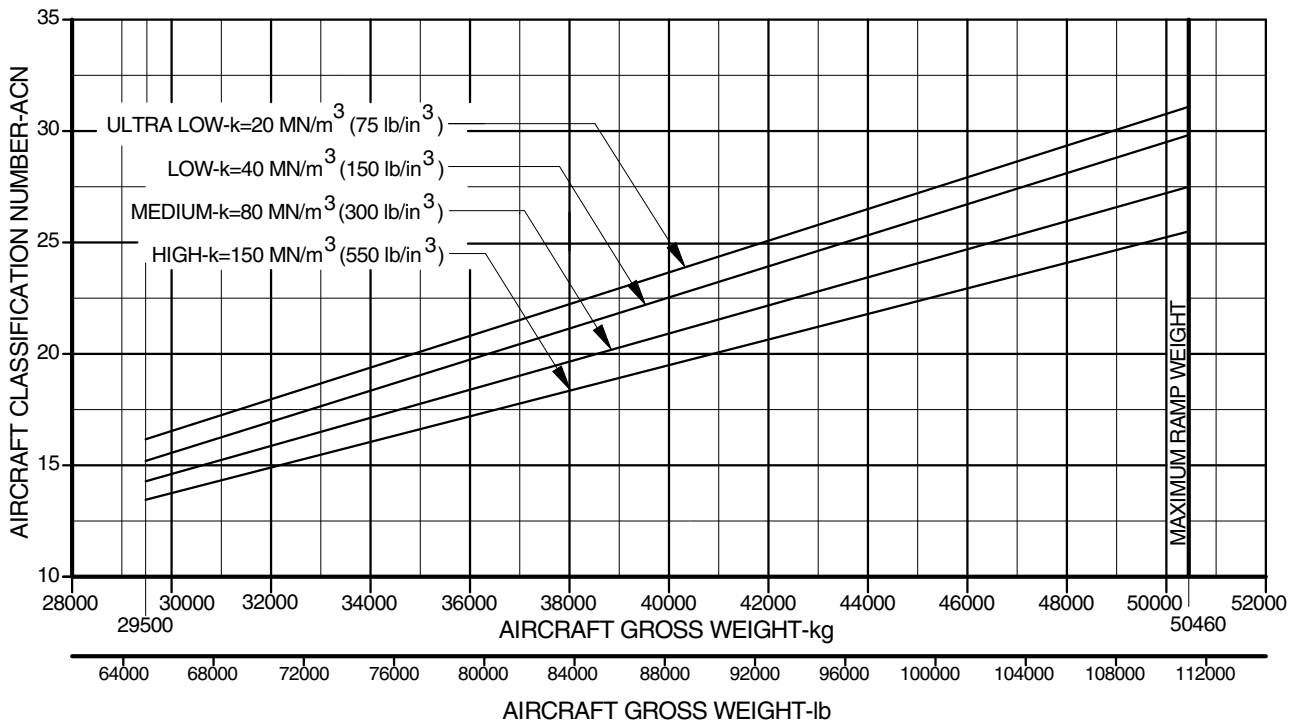
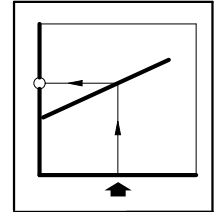

EM170APM070041C.IDR



8. **POSSIBLE EMBRAER 190 DERIVATIVE AIRCRAFT**

EFFECTIVITY: ALL

8.1. **NOT APPLICABLE**

**9. SCALED DRAWINGS***EFFECTIVITY: ALL***9.1. GENERAL**

This section provides plan views to the following scales:

- English/American Customary Weights and Measures
 - 1 inch = 32 feet
 - 1 inch = 50 feet
 - 1 inch = 100 feet
- Metric
 - 1:500
 - 1:1000



EFFECTIVITY: ALL
 Scale: 1 Inch Equals 32 Feet
 Figure 9.1

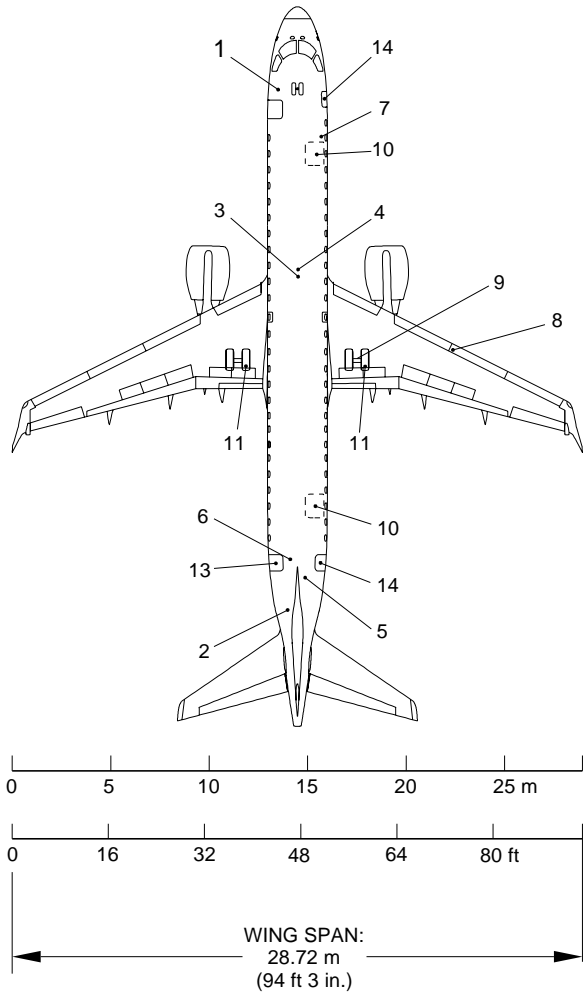

| ITEM | DESCRIPTION | ITEM | DESCRIPTION |
|------|--------------------------------|------|--------------------------------|
| 1 | EXTERNAL POWER SUPPLY 115 VAC | 8 | PRESSURE REFUELING / DEFUELING |
| 2 | EXTERNAL POWER SUPPLY 28 VDC | 9 | GROUNDING POINT (RIGHT MLG) |
| 3 | ENGINE AIR STARTING | 10 | CARGO DOOR |
| 4 | AIR CONDITIONING LOW PRESSURE | 11 | MAIN LANDING GEAR |
| 5 | WASTE SERVICING PANEL | 12 | NOSE LANDING GEAR |
| 6 | POTABLE WATER SERVICING PANEL | 13 | PASSENGER DOOR |
| 7 | OXYGEN REFILL / REPLACE BOTTLE | 14 | SERVICE DOOR |

EM170APM090006.DGN



EFFECTIVITY: ALL

Scale: 1 Inch Equals 50 Feet

Figure 9.2

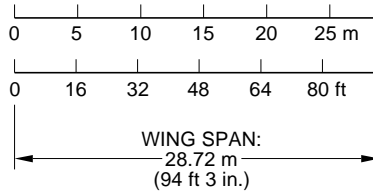
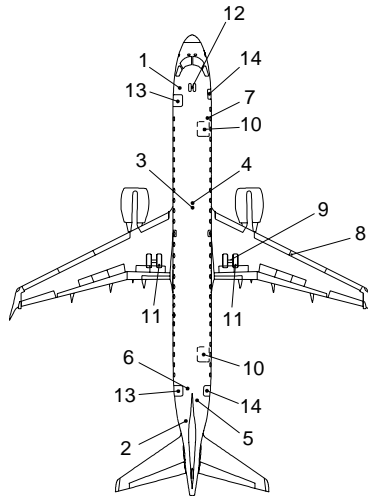

| ITEM | DESCRIPTION | ITEM | DESCRIPTION |
|------|--------------------------------|------|--------------------------------|
| 1 | EXTERNAL POWER SUPPLY 115 VAC | 8 | PRESSURE REFUELING / DEFUELING |
| 2 | EXTERNAL POWER SUPPLY 28 VDC | 9 | GROUNDING POINT (RIGHT MLG) |
| 3 | ENGINE AIR STARTING | 10 | CARGO DOOR |
| 4 | AIR CONDITIONING LOW PRESSURE | 11 | MAIN LANDING GEAR |
| 5 | WASTE SERVICING PANEL | 12 | NOSE LANDING GEAR |
| 6 | POTABLE WATER SERVICING PANEL | 13 | PASSENGER DOOR |
| 7 | OXYGEN REFILL / REPLACE BOTTLE | 14 | SERVICE DOOR |

EM170APM090007.DGN



EFFECTIVITY: ALL
 Scale: 1 Inch Equals 100 Feet
 Figure 9.3

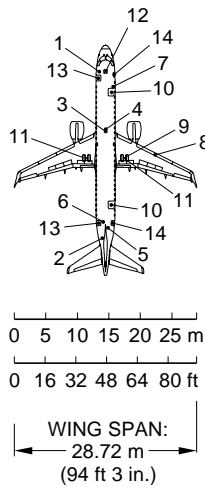

| ITEM | DESCRIPTION | ITEM | DESCRIPTION |
|------|--------------------------------|------|--------------------------------|
| 1 | EXTERNAL POWER SUPPLY 115 VAC | 8 | PRESSURE REFUELING / DEFUELING |
| 2 | EXTERNAL POWER SUPPLY 28 VDC | 9 | GROUNDING POINT (RIGHT MLG) |
| 3 | ENGINE AIR STARTING | 10 | CARGO DOOR |
| 4 | AIR CONDITIONING LOW PRESSURE | 11 | MAIN LANDING GEAR |
| 5 | WASTE SERVICING PANEL | 12 | NOSE LANDING GEAR |
| 6 | POTABLE WATER SERVICING PANEL | 13 | PASSENGER DOOR |
| 7 | OXYGEN REFILL / REPLACE BOTTLE | 14 | SERVICE DOOR |

EM170APM090008.DGN



EFFECTIVITY: ALL

Scale: 1 to 500

Figure 9.4

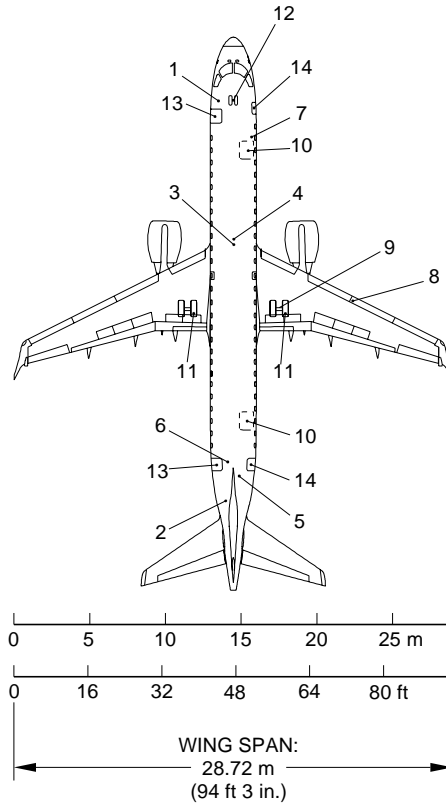

| ITEM | DESCRIPTION | ITEM | DESCRIPTION |
|------|--------------------------------|------|--------------------------------|
| 1 | EXTERNAL POWER SUPPLY 115 VAC | 8 | PRESSURE REFUELING / DEFUELING |
| 2 | EXTERNAL POWER SUPPLY 28 VDC | 9 | GROUNDING POINT (RIGHT MLG) |
| 3 | ENGINE AIR STARTING | 10 | CARGO DOOR |
| 4 | AIR CONDITIONING LOW PRESSURE | 11 | MAIN LANDING GEAR |
| 5 | WASTE SERVICING PANEL | 12 | NOSE LANDING GEAR |
| 6 | POTABLE WATER SERVICING PANEL | 13 | PASSENGER DOOR |
| 7 | OXYGEN REFILL / REPLACE BOTTLE | 14 | SERVICE DOOR |

EM170APM090009.DGN



EFFECTIVITY: ALL
 Scale: 1 to 1000
 Figure 9.5

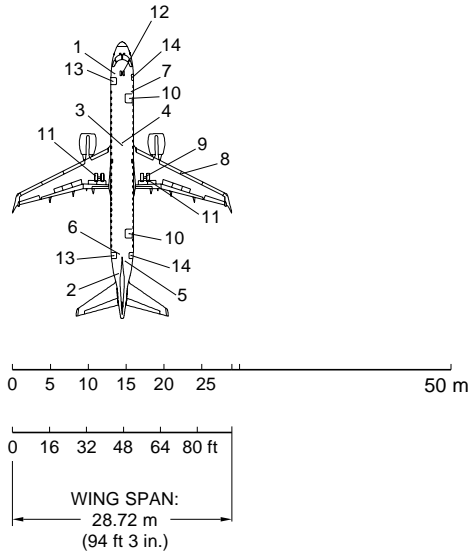

| ITEM | DESCRIPTION | ITEM | DESCRIPTION |
|------|--------------------------------|------|--------------------------------|
| 1 | EXTERNAL POWER SUPPLY 115 VAC | 8 | PRESSURE REFUELING / DEFUELING |
| 2 | EXTERNAL POWER SUPPLY 28 VDC | 9 | GROUNDING POINT (RIGHT MLG) |
| 3 | ENGINE AIR STARTING | 10 | CARGO DOOR |
| 4 | AIR CONDITIONING LOW PRESSURE | 11 | MAIN LANDING GEAR |
| 5 | WASTE SERVICING PANEL | 12 | NOSE LANDING GEAR |
| 6 | POTABLE WATER SERVICING PANEL | 13 | PASSENGER DOOR |
| 7 | OXYGEN REFILL / REPLACE BOTTLE | 14 | SERVICE DOOR |

EM170APM090010.DGN